



MONITORED SECURITY FENCING



ENERGIZERS AND ACCESSORIES
2023/2024



JVA Technologies (Australia), in partnership with **JVA (South Africa)**, has drawn on over 50 years' experience in some of the world's most testing international and local security markets, to produce a product range to satisfy the needs of the world security electric fencing markets ranging from simple domestic requirements, to high security installations. JVA products and expertise have become trusted choices for local and international customers as they meet the strict specifications required to secure important government contracts for prisons, airports, power stations, banks, housing estates, defence facilities and municipalities.

JVA's global partnerships enable it to combine award winning Australian engineering design expertise with South African, cost effective, assembly and accessory manufacture. From lessons learnt in challenging African, South American, Asian and other world markets, combined with the high tech demands of Australia and countries such as America, Africa and Europe, JVA engineers have succeeded in producing a robust product range that continuously sets international standards of quality, innovation and cost effectiveness.

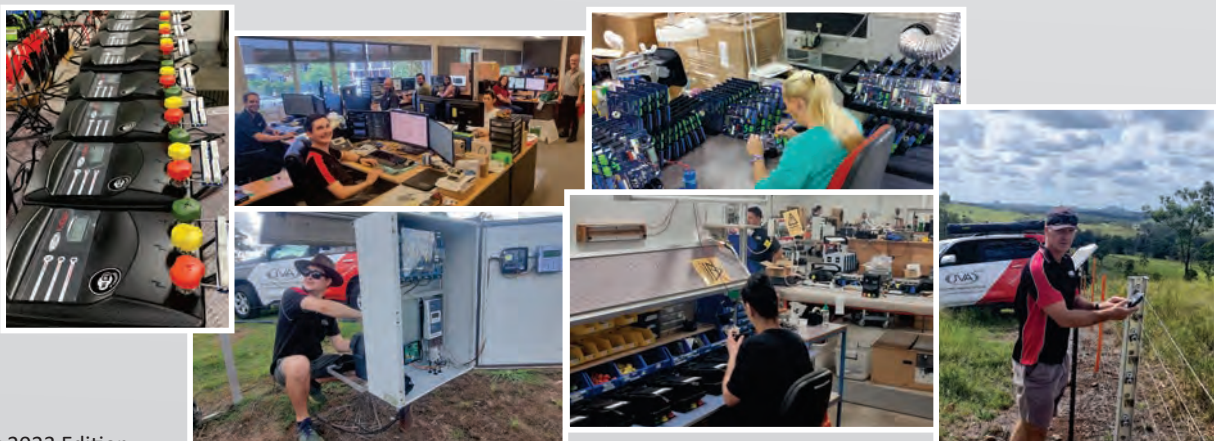

July 2023 Edition



CONTENTS

Introduction.....	2	JVA Perimeter Patrol Integration Functionality.....	26
JVA Z11 & Z13 Economy Security Energizers.....	3	JVA Multi-Zone Methods.....	28
JVA Z14, Z18 & Z114 Energizers	4	JVA Network Interface Boards.....	29
What is Bi-Polar Fencing?.....	4	JVA GSM and Wi-Fi Cloud Router Gateways.....	30
JVA Z25 & Z28 Energizers	5	JVA Electric Fence Management Devices.....	31
JVA Keypad.....	6	Electric Fence Applications.....	32
JVA Android Keypad.....	7	Around the world with JVA.....	35
JVA Specifications.....	8	Free-Standing Poles, Posts & Standards.....	38
JVA Jumbo Energizer.....	10	Wall-Top Brackets.....	40
JVA Agricultural Mid-Range LED Energizers.....	12	JVA Coastal Range of Plastic Brackets.....	42
JVA Agricultural High Powered LCD Energizer Range...12		Options available to Strain a Wall-Top fence.....	44
JVA Portable Energizer Range.....	13	Tensioners.....	45
JVA Pet100 Kit.....	13	JVA Electric Fence Tamper Switch.....	46
JVA BM1 High Voltage Fence Monitor.....	14	Insulators.....	47
JVA IPM High Voltage Fence Monitor and Switch.....	14	JVA Taut Wire Monitoring Solutions.....	48
JVA ZM1 Intelligent Monitoring System.....	15	JVA Genius Taut Wire Tensioner.....	49
JVA ZLM1 & ZLM4 Low Voltage Monitoring Systems...16		Gate In-line Series Circuit.....	51
JVA VM2 Vibration Detection Monitor.....	17	Accessories.....	52
JVA ZM20 & ZM50 Sector Fence Monitoring Systems.18		Lightning & Surge Protection.....	55
JVA ZM20 & ZM50 Multi-Zone, Multi-Sector Systems.19		Wireless, Outdoor, Double, Wide-Angled Beams..	57
Pulse Synchronization.....	20	JVA RFI Interface Module.....	59
JVA Wireless System.....	22	After Sales Service, Repairs & Consultancy.....	60
JVA Perimeter Patrol.....	24	Training.....	60
JVA Site Monitor with High Level Interface.....	25	Do's & Don'ts of Electric Fencing.....	61



Introduction

Welcome to the world of JVA monitored electric security fences. The proliferation of non-lethal, monitored, electric security fences in our towns and cities is indicative of the confidence the public has in this form of perimeter security. The reason for this popularity is simple – monitored electric security fences are effective, economical, relatively simple to install, and the JVA Electric Security Fence offers more Ds of security than any other perimeter system:

- Demarcation** – The JVA fence around your property shows you mean business.
- Deflection** – Would-be intruders will be deflected to softer targets.
- Deterrence** – The safe, powerful JVA shock is a strong deterrent to intruders.
- Delay** – The physical barrier will delay an intruder; something they do not like.
- Detection** – The JVA's voltage monitor warns you of any tampering with the fence.
- Deny** – A well-erected electric security fence will deny entry.
- Dependable** – 60 seconds a minute, 60 minutes an hour, 24 hours a day, 365 days a year, your JVA electric security fence is monitored by an alert, sober, electronic watchman.

Every second the JVA energizer discharges a very short duration, safe, high voltage impulse down the fence live wire. The JVA security energizer then monitors the voltage at the end of this live wire, thereby checking that the voltage is being maintained along the entire fence line. In the event of a voltage drop caused by either shorting, cutting or poor maintenance, the monitor will trigger an alarm, thus alerting you.

Manufactured to meet the most stringent international safety standards, the JVA Range is in a class of its own when it comes to features and benefits at an affordable price.

JVA Z11 & Z13 Economy Security Energizers



Z13

The JVA Z11 and Z13 Single-Zone Security Energizers are the entry level energizers in the Z-Range. They are manufactured to meet customer demand for a simple, no-frills, economical unit for small, domestic, commercial and industrial sites. The units are fully compatible with the Z-Range keypad and when wired up to a keypad are fully programmable. All Z-Range energizers, with the addition of a Wi-Fi Board can be fully controlled from a mobile phone.



PAE253



Features

- High Voltage, Single-Zone Fence Monitor triggers alarm when the live wires are tampered with
- Earth Wire Monitor triggers alarm when the earth wires are tampered with
- Gate Monitor input, to monitor the gate
- 1.8 joules and 3 joules maximum output energy, respectively
- Compliant with IEC60335-2-76
- Built-in Lightning and Surge Protection
- Internal Battery Backup in case of power failure
- Up to 24-Hour Monitoring in the event of a power failure
- Low Power Option – Ideal for locations where monitoring is required but high voltage is not required 24 hours on the fence
- Energizer supplied with secure Key-Switch Operation
- Diagnostic Mode
- Keypad Compatible – Use optional Z-Range Keypad
- Dynamic Voltage Monitoring minimizing arcing and false alarms while maximizing power and battery life

Basic Fence Design

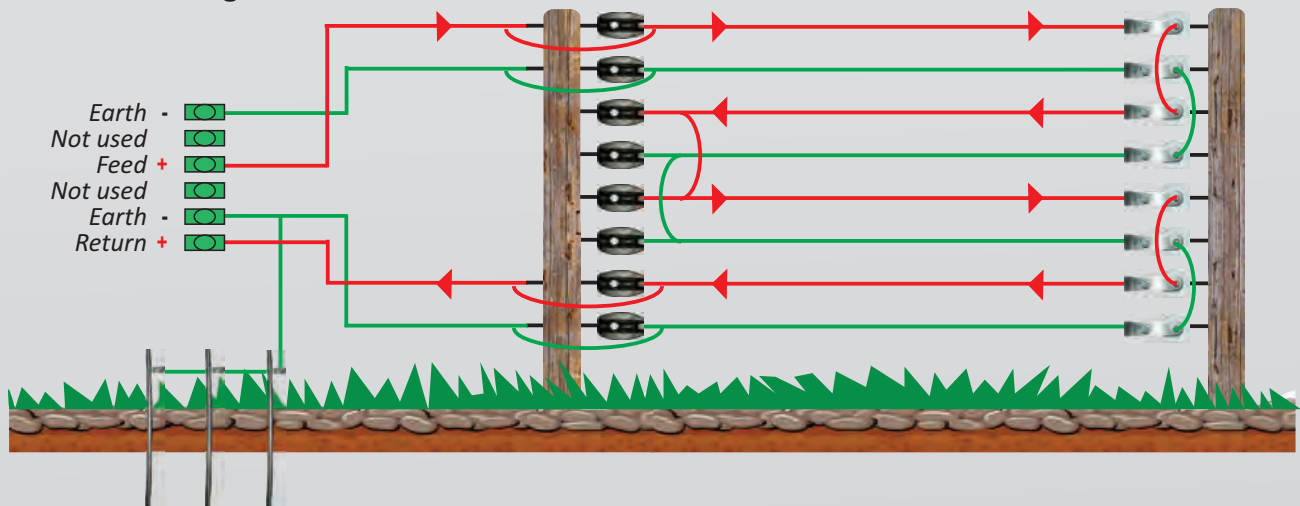

JVA Z14, Z18 and Z114 Energizers



The JVA Z-Range of Single-Zone Security Energizers with LCD displays are top-of-the-range energizers meeting all requirements from the basic home security fence to fully integrated high profile installations. These energizers have LCD displays showing out and return voltages, battery condition and fence programming settings. The units are fully compatible with the Z-Range keypad and, when wired up to a keypad, are fully programmable. The energizers can be networked with other Z-Range energizers to synchronize pulses and become a multi zone group for larger sites where many zones are required. These energizers can be controlled by a PC or up to 3 keypads, or 1 keypad can control up to 14 Z-Range energizers.

Features

- High Voltage, Single-Zone Fence Monitor triggers alarm when live wires are tampered with
- Earth Wire Monitor triggers alarm when the earth wires are tampered with
- LCD Voltage Feed and Return Display
- Gate Monitor input to monitor the gate
- Dynamic Voltage Monitoring minimizing arcing and false alarms while maximizing power and battery life
- 5, 8 and 14 joules maximum output energy respectively
- Compliant with IEC60335-2-76
- Built-in Lightning and Surge Protection
- Up to 24-Hour Monitoring in the event of a power failure
- High and low power options
- Energizer supplied with secure Key-Switch Operation
- Diagnostic Mode
- 2 Standard Fully Programmable Relays plus option for 3 more on request
- Keypad Compatible – Use a Z-Range Keypad
- Programmable to Bi-Polar or Standard
- Pulse Synchronization in group mode
- Anti-Tamper option programmable on request
- Internal Battery Backup in case of power failure

What is Bi-Polar fencing?

The JVA Z14, Z18 and Z114 Energizers can be programmed to Bi-Polar mode. This gives rise to the question: What is Bi-Polar Fencing and what exactly are the benefits of this wiring configuration? A Bi-Polar fence is an all-live wire fence.

A Bi-Polar Energizer has the ability to pulse synchronized positive and negative pulses down alternate wires of the same fence line. So, instead of having alternate live and earth wires on the same fence line, one now has one wire with a positive pulse and one wire with a negative pulse.

This means that all the wires on the security fence are live, with the exception of the open true-earth wire in the fence grid, should one be included. A reading taken between the positive pulsing or negative pulsing live wires and the earth, will give half the voltage of a normal live/earth configuration. However, when one touches both the positive and negative pulsing wires, one will receive the 'full monty'.

The big plus factor of this configuration is that, by reducing the voltages to each wire, one helps eliminate the annoying and often difficult-to-eliminate arcing experienced in coastal or dusty areas.

Bi-Polar Fence Design

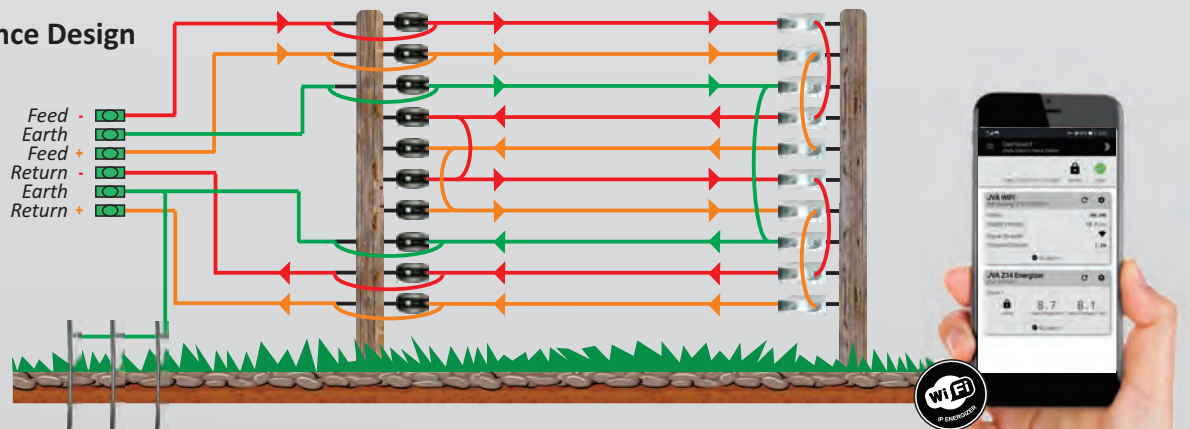

JVA Z25 and Z28 Energizers



The JVA Z25 and Z28 Dual-Zone Security Energizers with LCD displays are top-of-the-range high power energizers, ideal for installations where better zone identification is required. The Z25 and Z28 can meet all requirements from longer wall-top fences to industrial and high profile installations. The energizer has an LCD display showing return voltages for each zone, battery condition and fence programming settings. The unit is fully compatible with the optional Z-Range Keypad and when wired up to a keypad is fully programmable. The energizer can be linked with other Z-Range Energizers to synchronize pulses and become a multi zone group for larger multi zone sites. The Z25 and Z28 can be controlled by a PC or up to 3 keypads, or 1 keypad can control up to 14 Z-Range Energizers.

The Z25 and Z28 are unique in that each zone is individually controllable, allowing each to be individually operated and programmed via the keypad. Unlike many other energizers available in the market, a short on one zone on the Z28 will have no effect on the voltage on the other zone. The Z28 is in essence two Z14 Energizers in one. This means that each zone, powered by one Z28, can be individually armed or disarmed in high or low voltage mode – an excellent safety feature.

Features

- High Voltage, Dual-Zone Fence Monitor triggers alarm when live wires are tampered with
- Earth Wire monitor triggers alarm when the earth wires are tampered with
- LCD Voltage Return Display for both zones
- Gate Monitor inputs to monitor the gates
- 2.5 - 5 Joules maximum output energy per zone
- Compliant with IEC60335-2-76
- Built-in Lightning and Surge Protection
- Internal Battery Backup in case of power failure
- High and low power options
- Dynamic Voltage Monitoring minimizing arcing and false alarms while maximizing power and battery life
- Energizer supplied with secure key switch operation
- Diagnostic Mode
- 3 Standard programmable relays (1 siren and 2 strobe) – excellent for communication
- Optional extra Relay Board on request – total 6 relays
- Keypad Compatible – Add Z-Range Keypad
- Up to 18-Hour Monitoring in the event of a power failure
- Pulse Synchronization

Certification

It is a legal requirement, both locally and internationally, that electric fence energizers must comply with stringent safety criteria as stipulated in IEC 60335-2-76:2006. JVA Energizers comply with these standards. All JVA units are tested and certified by Power Lab Limited and Test Africa, both internationally accredited test laboratories.



LCD Display

- Fence feed and return Voltage Display on Z14 and Z18
- Fence Return Voltage Display on Z28 and Bi-Polar models
- Actual Battery Voltage
- Low Battery Warning
- Battery Condition
- Programme Settings
- Software Version
- Diagnostic Feed-Back

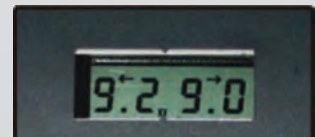

TWO-YEAR WARRANTY

All JVA products carry a 2-year warranty against defective components and workmanship. The warranty excludes damage caused by acts of Nature such as lightning or flooding, power supply surges, rough handling, malicious action or incorrect wiring.

Please retain your invoice as proof of purchase and fill in the warranty form provided in the manual.

**2-Year
WARRANTY**

JVA Arming Devices

The standard JVA Energizer can be chosen with a key-switch or a magnetic tag to arm and disarm the unit.



Magnetic Keys



Radial Keys

OR



Remote Kit Available

JVA Keypad

JVA Menu-driven Keypad

The JVA Z-Range Keypad is manufactured specifically for the JVA Z-Range. JVA has simplified things by designing one keypad to operate the full range of Z-Energizers from a simple home Z11 system to a high profile multi-zone system. The JVA Keypad with its backlit LCD display gives the user, at a glance, all the information that may be required. The JVA Keypad displays feed and return voltages and can be fully customized with custom messages and names for Zones and Gates – e.g. *Front Gate/Back Fence*, etc.



Z14KP

Features

- One JVA Keypad operates the full Z-Range
- Backlit LCD Display
- 1 to 14 energizers can be controlled from one keypad
- 1 to 3 keypads can be used to control one energizer
- Zone Voltage displayed on the keypad
- Zone Voltage Scrolling Function display for Multi-Zone systems
- Simple 3-wire operation
- Battery Voltage Request display to energizer LCD
- User menu-driven display
- Ability to customize zone and gate names
- Maximum 100m on conventional communication cable



Keypad 1



Keypad 2



Keypad 3



Unit 1



Keypad 1



Unit 1



Unit 2



Unit 3



Unit 4



Unit 14



Perimeter Patrol Software



Unit 1



Unit 2



Unit 3



Unit 14

JVA Android Keypad

JVA 9-Inch Android Keypad with housing

The JVA Touch Screen Keypad is an ideal intermediary between the 4-line Keypad and a full PC based JVA Perimeter Patrol System. The JVA Touch Screen Keypad is manufactured specifically for the control and management of the full range of JVA Z-Range Energizers and Monitors, from a simple home Z11 to a high profile multi-zone ZM20 system. The 9-inch screen is protected by a tamper resistant steel case which gives the user, at a glance or a touch, all the information that may be required.



Features

- New easy-to-use graphical user interface, touch screen keypad for the JVA Z-Series Range
- Quick setup guide to ensure the site is correctly configured
- Alarms and status notifications can be sent to a user via email by utilizing the built-in Wi-Fi connection
- Menu-driven programming interface for devices: each device can have its unique settings programmed from a drop-down list of possible values, with names and descriptions of each setting available
- Accurate 500 event log
- Separate Installer and User logins with individual permissions and photo capture
- Personalized map can be loaded from Internet or from SD Card
- Zone names can be personalized
- Zone mimic lines can be added on map for easy identifying of zones
- Fence feed and return voltages displayed
- Built-in Wi-Fi Gateway, JVA Energizers and Monitors can be integrated easily into the JVA Cloud Router® and monitored via an Internet enabled device (cell phone, PC or tablet)
- Ability to load and save site configurations, including device configurations, custom zone names and configurations, which means that ZM20 sector programming and common setups can be saved and quickly loaded into a new device
- Software updates available over Wi-Fi

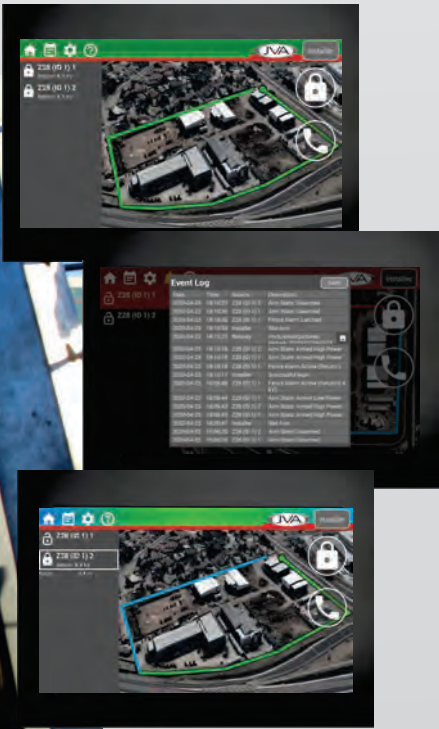

JVA Specifications

SPECIFICATIONS	Z11	Z13	Z14	Z18	Z114	Z25	Z28
Stored energy	3J	5J	6J	12J	17J	2x4J	2x6J
Maximum Output energy	1.8J	3J	5J	8J	14J	2x2.5J	2x4J
Output voltage maximum	10kV	10kV	10kV	10kV	10kV	10kV	10kV
Output voltage LCD display	Keypad	Keypad	✓	✓	✓		
Return voltage LCD display	Keypad	Keypad	✓	✓	✓	✓	✓
Backup time maximum	24hrs	24hrs	18hrs	18hrs	16hrs	16hrs	14hrs
Ext 16VAC transformer	✓	✓	✓	✓	✓	✓	✓
Battery volts	12V	12V	12V	12V	12V	12V	12V
Battery capacity	7Ah	7Ah	7Ah	7Ah	9Ah	7Ah	7Ah
Pulse frequency	0.8hz	0.8hz	0.8hz	0.8hz	0.8hz	0.8hz	0.8hz
Pulse width	0.3ms	0.3ms	0.3ms	0.3ms	0.3ms	0.3ms	0.3ms
Alarm delay	*	*	*	*	*	*	*
Siren time out	*	*	*	*	*	*	*
Bi-Polar capability			✓	✓	✓		

* Programmable by keypad

RECOMMENDED SERIES WIRE LENGTH	Z11	Z13	Z14	Z18	Z114	Z25	Z28
1.2mm SS	0.6km	0.8km	1km	1.5km	2km	2x0.6km	2x1km
1.6mm SS	1.2km	1.4km	1.6km	2km	2.5km	2x1.2km	2x1.6km
2mm SS	1.8km	2.1km	2.4km	3.3km	3.6km	2x2km	2x2.4km
1.2mm braided galvanized	2km	3km	4km	8km	10km	2x2.5km	2x4km
2mm braided galvanized	2.5km	3.5km	5km	8km	10km	2x3km	2x5km
2.24 galvanized HSS	3km	4km	6km	10km	14km	2x3.5km	2x6km
1.6mm aluminium wire	6km	8km	10km	20km	25km	2x6km	2x10km

DIMENSIONS	Z11	Z13	Z14	Z18	Z114	Z25	Z28
Size (height, width, depth) mm	300x190x115	300x190x115	300x190x115	300x190x115	300x190x115	300x190x115	300x190x115
Weight (without battery)	2.0kg	2.0kg	2.1kg	2.4kg	3kg	2.2kg	2.4kg

POWER CONSUMPTION	Z11	Z13	Z14	Z18	Z114	Z25	Z28
Average current draw	500mA	500mA	550mA	1000mA	1200mA	900mA	1000mA
Peak current draw	600mA	600mA	750mA	1200mA	1400mA	1100mA	1200mA

All energizers in the Z-Range can be used in a Multi-Zone Network

JVA Specifications

SOLAR PANEL SPEC	Z11	Z13	Z14	Z18	Z114	Z25	Z28
Recommended battery	50Ah	50Ah	50Ah	105Ah	105Ah	105Ah	105Ah
Solar panel	60w	75w	75w	100w	120w	100w	120w
Solar regulator	10A	10A	10A	10A	20A	10A	10A

Solar panel calculations based on an installation in Johannesburg, South Africa.
Location-specific recommendations available on request.

WARRANTY	Z11	Z13	Z14	Z18	Z114	Z25	Z28
2-year warranty	✓	✓	✓	✓	✓	✓	✓

CERTIFICATION	Z11	Z13	Z14	Z18	Z114	Z25	Z28
Compliant (IEC60335-2-76)	✓	✓	✓	✓	✓	✓	✓

FEATURES	Z11	Z13	Z14	Z18	Z114	Z25	Z28
Fence monitor	✓	✓	✓	✓	✓	✓	✓
Gate (aux.) monitor	✓	✓	✓	✓	✓	✓	✓
Low voltage monitor	✓	✓	✓	✓	✓	✓	✓
Siren driver	✓	✓	✓	✓	✓	✓	✓
Strobe driver	✓	✓	✓	✓	✓	✓	✓
Armed response	✓	✓	✓	✓	✓	✓	✓
On/Off reset key	✓	✓	✓	✓	✓	✓	✓
Remote control option	✓	✓	✓	✓	✓	✓	✓
Battery backup	✓	✓	✓	✓	✓	✓	✓
Keypad LCD optional	✓	✓	✓	✓	✓	✓	✓
Multi-Keypad compatible	✓	✓	✓	✓	✓	✓	✓
Keypad voltage display	✓	✓	✓	✓	✓	✓	✓
Keypad tamper alert	✓	✓	✓	✓	✓	✓	✓
Microprocessor	✓	✓	✓	✓	✓	✓	✓
Programmable	✓	✓	✓	✓	✓	✓	✓
Earth monitoring	✓	✓	✓	✓	✓	✓	✓
Security	✓	✓	✓	✓	✓	✓	✓
Software controllable	✓	✓	✓	✓	✓	✓	✓
Solar power option	✓	✓	✓	✓	✓	✓	✓
Number of zones	1	1	1	1	1	2	2
Multi-zone pulse sync	✓	✓	✓	✓	✓	✓	✓

JVA Jumbo Energizer

The JMB series is the most powerful and feature rich electric fence energizer JVA has manufactured to date. This continues JVA's push for technical superiority in the area of Monitored Electric Fencing and IP Energizers®. While the JMB energizers were specifically designed for game parks and exclusion fencing, they are also well suited to any large permanent electric fencing application. The JMB series generates up to a remarkable 46J of stored energy, currently the world's most powerful battery powered energizer.

A monitored electric fence reduces maintenance by reporting whenever there is a fault and by allowing you to check the fence from wherever you are using the Internet.

The JMB series introduces the JVA Virtual Keypad. This allows you to monitor, control and program the energizer from your Wi-Fi enabled smart device (cell phone, tablet or laptop). The JMBs can also be controlled and monitored with a wired JVA 4-Line Keypad supplied with the unit.



24/7 Fence Information available via GSM or Wi-Fi



Virtual Keypad Programming via Smart Device

Features

- Combined electric fence energizer and monitor
- Power or Loop Monitor depending on model
- Virtual Keypad via your Wi-Fi enabled device (phone, tablet or laptop)
- Distant Fault Detection (DFD™) technology
- High powered (up to 46J stored)
- Mains or 12V battery powered (mains via supplied 24V plug pack)
- Lightning protection on all fence connections
- No mains inverter required to run on solar and battery
- Power on demand, i.e. it generates the power only required for the fence conditions
- Able to be controlled and/or monitored through multiple options
- Built-in 1Amp backup battery charger
- 1 Siren and 2 Strobe 12V outputs for stand-alone security installations (switched 12V DC)
- On/Off switch
- Programmable relays



JVA Jumbo Energizer

JMB ZM50

The JMB ZM50 contains our patented Loop Monitor with Distant Fault Detection (DFD™). The loop, or loops of live wires may run down and back on the same fence or all the way around a property. While previous fence loop monitors suffered from a range limitation of approximately 10km of fence or 30km of wire, DFD™ has greatly increased this range.

Features

- Can split a single fence into up to 50 sectors
- Can report the position of a fault as a percentage of overall fence length
- Short sectors can be defined accurately using JVA sector dividers
- ELV (Extra-low Voltage) open circuit detection



Live: Series Wired – Ground: Parallel Wired

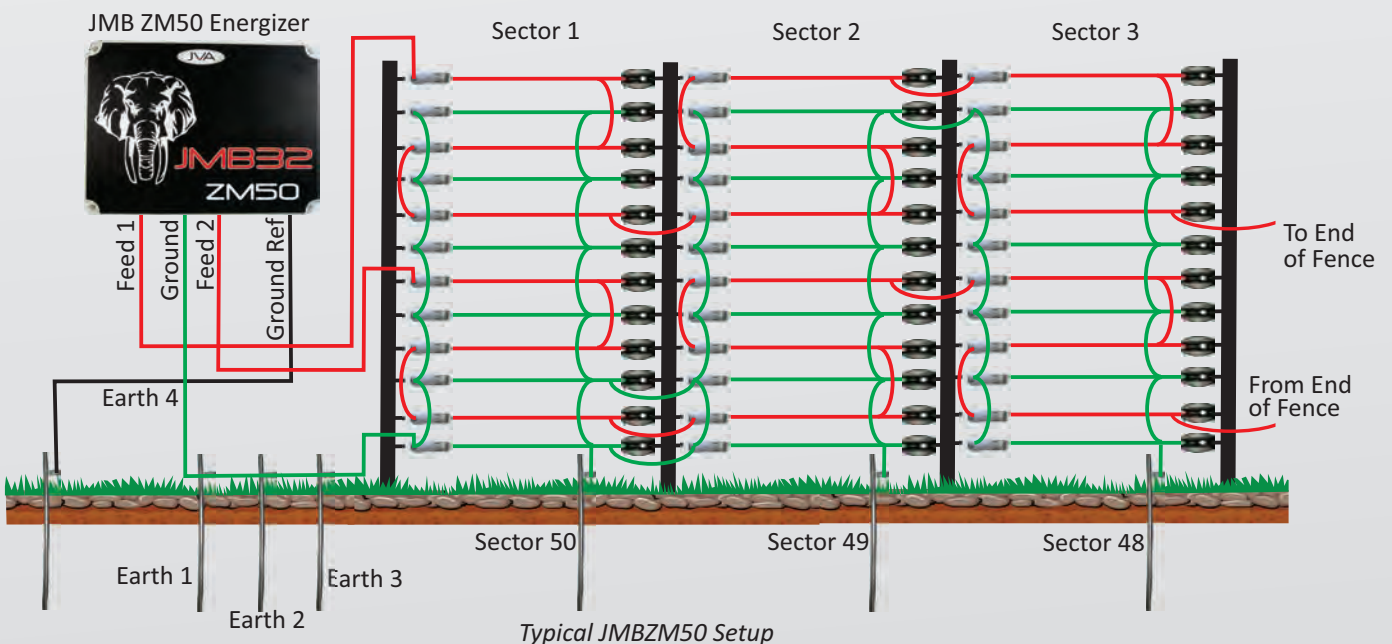

JVA Jumbo Range Specifications

Model	Stored Energy	Output Energy	Zones	Sectors	Input Voltage	Power Peak
JMB32ZM1	46	32	1	0	12/24V	3.6A at 13.5V DC
JMB32ZM2	2x23	2x16	2	0	12/24V	3.6A at 13.5V DC
JMB32ZM50	46	32	1	Up to 50	12/24V	3.6A at 13.5V DC
JMB25ZM1	36	25	1	0	12/24V	2.8A at 13.5V DC
JMB25ZM2	2x18	2x12.5	2	0	12/24V	2.8A at 13.5V DC
JMB25ZM50	36	25	1	Up to 50	12/24V	2.8A at 13.5V DC
JMB16ZM2	23	2x8	2	0	12/24V	2.5A at 13.5V DC
JMB8ZM1	11.5	8	1	0	12/24V	1.8A at 13.5V DC
JMB10ZM2	14	2x5	2	0	12/24V	2.0A at 13.5V DC
JMB8ZM50	11.5	8	1	Up to 50	12/24V	1.8A at 13.5V DC

Solar Recommendation 32 Joule Units	Area Table 6 Hours Sun	350W	200Ah Battery
Solar Recommendation 25 Joule Units	Area Table 6 Hours Sun	300W	200Ah Battery
Solar Recommendation 8 Joule Units	Area Table 6 Hours Sun	150W	100Ah Battery

JVA Agricultural Mid-Range LED Energizers

Battery and Mains LED Energizers

The MB1.5, MB3.0 and MB4.5 Electric Fence Energizers are capable of between 1.5 and 4.5 Joules output energy per pulse. This innovative design means that you can have versatile portable power from a 12V battery when needed, or run it from 240V AC mains electricity where that is available. Optional JVA Solar Kits and external batteries are available on request to make these units fully portable.



	MB1.5	MB3.0	MB4.5
Stored Joules	2J	4J	6J
Energy Output	1.5J	3J	4.5J
Power Consumption at 12.5V DC	0.15A	0.3A	0.5A
Recommended Fence Line Distance	2Km	3Km	4Km

JVA Agricultural High Power LCD Energizers

Mains/Battery High Power LCD Energizers

The MB8, MB12 and MB16 IP Energizers® have 8, 12 and 16 joules output energy respectively and can be controlled from anywhere in the world using your mobile phone App, providing an internet connection is available.. The energizers have an LCD display to show fence voltage and joules. These newly styled energizers include an audible warning if there is a serious fault on the fence and Auto-Sync™ technology, all of which help keep your fences safe. These universal or mains/battery powered energizers give you the added option of running on 12V should you not have 240V available.



Features

- Mains powered
- Battery powered
- Digital control
- Smooth Wave shape
- Power on demand
- LCD showing Kv and stored energy
- Ant and moisture protection
- UV stable enclosure
- Overload indication (audible and visible)
- Lightning protection
- Reverse battery protection
- Remote Compatible
- Self-resetting fuse
- Solar capability
- Low battery indication
- Over discharge battery protection
- Battery life maximization
- Battery voltage measurement
- Power adaptor included
- Audible alarm
- Bi-Polar output
- 2-year warranty

	MB8	MB12	MB16
Stored Joules	12J	18J	23J
Energy Output	8J	12J	16J
Power Consumption at 12.5V DC	0.9 A	1.25 A	1.6 A
Recommended Fence Line Distance	8Km	10Km	12Km



JVA Portable Energizer Range

JVA SV10 and SV5 Solar Energizers

The SV10 & SV5 energizers are ready to go straight out of the box! A reliable built-in rechargeable battery and integrated solar panel make the JVA Solar Energizers totally portable, without the need for extra batteries and hardware. The energizers have an LCD display enabling you to see the voltage and joules on the fence at a glance. Just slide the energizer onto any Y-standard, connect the fence and switch it on. The SV10 Energizer has 1.0J output energy and the SV5 Energizer has 0.5J output energy per pulse. They are suitable for permanent and temporary fencing.



JPTE2161

JPTE2263



JPTE2234

JVA SV2 Solar Energizer

The SV2 Energizer is ready to go straight out of the box! A reliable built-in rechargeable battery and integrated solar panel make the JVA Solar Energizers are totally portable, without the need for extra batteries and hardware. Just slide the energizer onto any Y-standard, connect the fence and switch it on. The SV2 Energizer has 0.2J output energy per pulse.

JVA RSG1 Portable Energizer

The RSG1 is a portable 0.1J electric fence energizer with a built-in rechargeable battery, suitable for strip grazing and any small temporary fence applications. The RSG1 is packaged with both a 240V mains power adaptor and a 12V 'cigarette lighter' adaptor to recharge it. It will run for over two weeks between re-charges.



JVA Pet100 Kit

JVA Portable Pet Energizer

The Pet100 energizer has the option of being mains or battery powered. It has a nice compact design with a UV stable enclosure. For larger dogs and longer distances, pet electric fence kits can be made up by using strip grazing accessories and energizers.



JVAPET



JVA Pet Kit

JVA BM1 High Voltage Fence Monitor

The BM1 (PTE0211) is a basic electric fence monitor. It provides an alarm when your electric fence is cut or shorted or the energizer has been turned off. When connected to the end of the fence (return wire) the BM1 can monitor one complete circuit (zone) of electric fence.

This monitor can be powered from a 12V power supply, or a 12V battery. If you need the monitor to operate during a power failure, consider using a 12V lead acid battery that is being kept charged from a battery charger or solar panel.

The BM1 is intended for use with pulsed type electric fence energizers with output voltages of 10kV or less. The energizer should conform to IEC60335.2.76 or similar.

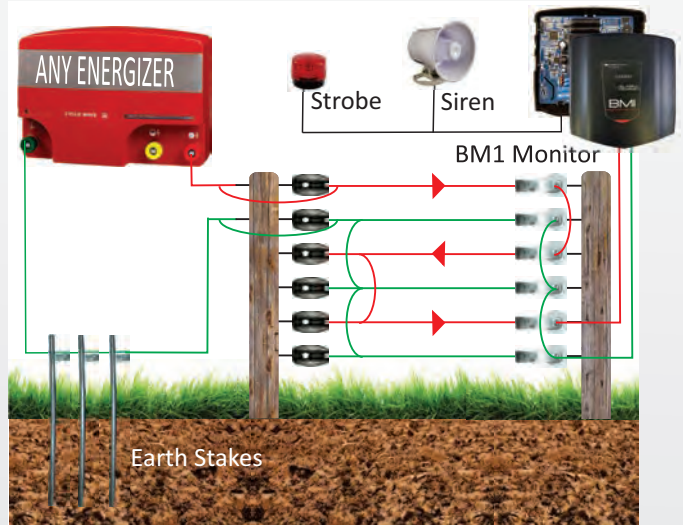

Series Wired Fence Line

JVA IPM High Voltage Fence Monitor and Switch



JPTE0256

The JVA IP Monitor is an Internet-connected electric fence monitor and switch. Using the free IP Energizer Controller App, it allows you to instantly see the status of your configured electric fence from anywhere in the world, switch the fence on and off, and even alerts you should fence voltage or current go beyond configurable thresholds. It works with any energizer and has built-in Wi-Fi technology, making connection a breeze.

Features

- Mains or 12V Battery operation
- Built-in Wi-Fi for direct internet connection
- Can use 3G/4G cellular network with a separate modem/hotspot
- High power internal relay
- Works with any energizer up to 36 Joules
- Start-of-fence or end-of-fence monitoring
- Can break a large fence system into separately controlled and monitored zones
- UV stable enclosure
- O-ring sealed case for ant and moisture protection
- IP Energizer Controller app available for iPhone and Android
- Designed and manufactured in Australia



Option 1: Monitor the start of the fence(s)

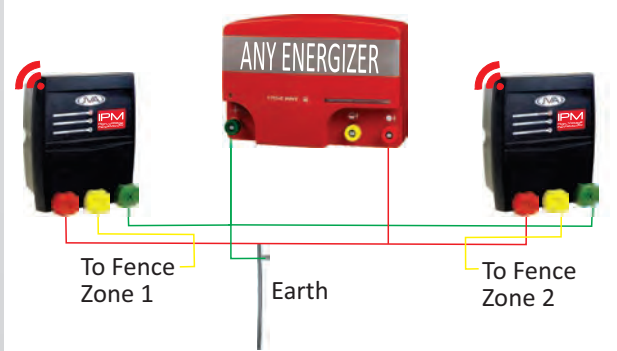

Option 2: Monitor the end of the fence(s)

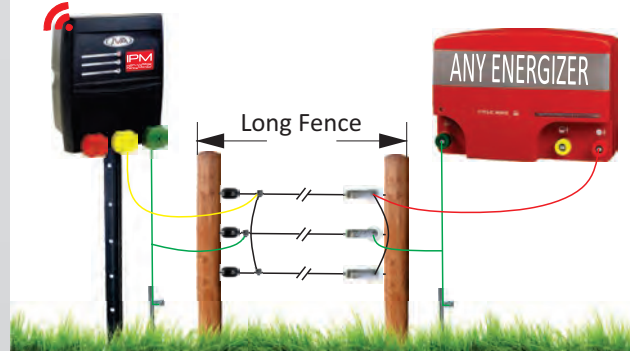

JVA ZM1 Intelligent Fence Monitoring System

The ZM1 is designed to be coupled with any standard electric fence energizer to power and monitor an electric fence. It can control large energizers, making it ideal on large agricultural, game and border security fences.

The combination of the ZM1 and the Energizer operates in the same way as a single JVA Z-Series energizer, with the exception that the pulse power level of the energizer cannot be modified.

The ZM1 monitors the live feed line from the energizer to the fence and determines if the fence is working properly, by measuring the voltage, current, and therefore power, flowing to the fence.

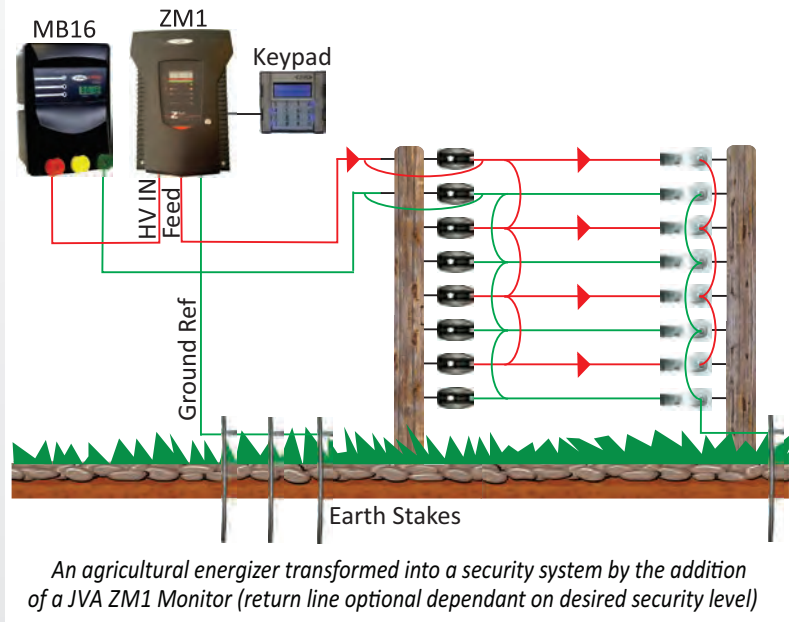

As such, it does not require a return line from the end of the fence. This can represent a large saving on installation costs on new fences or make monitoring an existing fence possible if no return line was originally wired. The ZM1 can, however, also monitor the return if that is desired.

The ZM1 has many programmable options which can be adjusted using a JVA Z-Series Keypad. By correctly setting the alarm threshold levels, it is possible to determine if a fence has been cut or shorted at any point. An energizer used with the ZM1 must comply with IEC6033-2-76 or a similar safety standard.

Features

- Built into the wall mountable Z-Range Energizer enclosure
- Does not require a return line
- LCD current display (load)
- LCD earth voltage display
- LCD voltage display for feed and return voltage
- Controllable and programmable via keypad with similar codes to the Z-Series
- Monitors fence voltage and current to trigger an alarm if current rises or voltage falls (load increases)
- Can be combined with any SANS IEC compliant energizer, below 63J output, to produce a fully featured, security electric fence energizer/monitor
- Start and end of fence monitoring
- Able to be monitored via PC (using Perimeter Patrol Software)
- Run from 16V AC or 12V DC external source
- Built-in battery charger plus connection for alternate larger external battery and charger
- Controls 12V DC feed to energizer
- Can control a 220V AC energizer via external relay (not supplied), (12V coil, 240V AC rated contacts)
- Remote On/Off or Key-Switch
- Gate contact input
- Siren and strobe 12V DC switched outputs, 3-on-board relays with many programmable functions

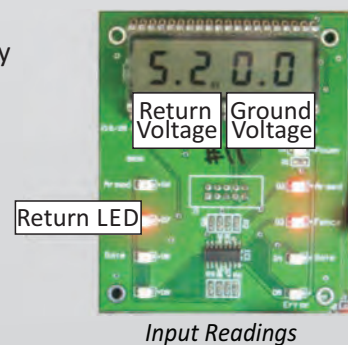
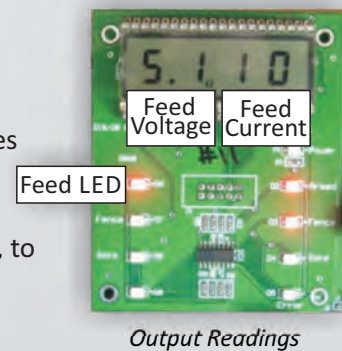

JVA ZLM1 & ZLM4 Low Voltage Monitoring Systems

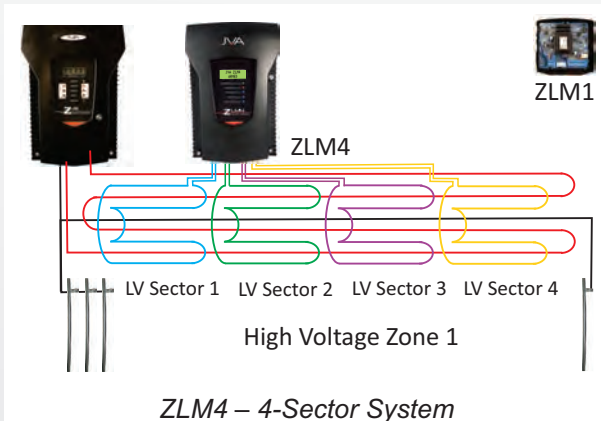

The JVA ZLM1 is a single zone low voltage electric fence monitor. The ZLM1 may be used by itself or in conjunction with a number of high voltage security electric fence energizers.

The ZLM4 is a 4-zone, low voltage, electric fence monitor. The ZLM4 may be used by itself or in conjunction with a number of high voltage security electric fence energizers. The ZLM4 monitors up to 4 loops of fence wire, each up to several hundred meters long, to detect someone tampering with the fence by cutting or shorting the wires.

When used in conjunction with a high voltage electric fence energizer, the ZLM4 is wired to the non-energized earth wires on the fence. In this way, the ZLM4 can be used to split one high voltage zone into up to 4 low voltage monitored zones for improved targeting of the response to potential security breaches. The ZLM4 is compatible with the JVA Z series energizers. It may be connected via a keypad bus network with other Z-series devices to enable the whole group to be controlled via one keypad, or linked to a PC running JVA Perimeter Patrol software.

The ZLM4 monitors a low voltage loop using intrinsically safe, isolated ELV DC. It employs a continuity check for detecting open circuits, DC voltage level sensing to detect a short to ground and pulse voltage sensing to detect a short to a line powered by a high voltage fence energizer. The advanced features of this device allow the performance to be tuned to the fence and to the particular requirements of the site. This is done by adjusting the device's programmable options. The ZLM4 will report an alarm on: detecting a low voltage loop cut (open circuit); shorted to ground (short); when high voltage from an electric fence energizer wire is shorted to the monitored low voltage loop; or when two low voltage loops short to one another (cross couple).

Features

- Can be used to split a single security electric fence zone into up to 4 low voltage zones
- Can detect a short, cut, or if the monitored wire is touching a high-voltage wire
- Optional LCD display – displays which zone is in alarm and other information
- Controlled and programmed via a JVA Keypad with similar codes to the JVA Z-Series
- Able to be integrated into third party access control and security information management systems at a variety of levels
- Enables the construction of systems from economical Key-Switch operations to complex PC controlled applications
- Runs from 16V AC or 12V DC external source
- Built-in battery charger for optional 7Ah backup battery
- Siren and strobe switched 12V DC outputs for stand-alone operation
- 2 Control inputs and 4 relays with many programmable functions for low level integration with other systems
- Fence connections are fully isolated from power and IO as per relevant part of ICE60335.2.76

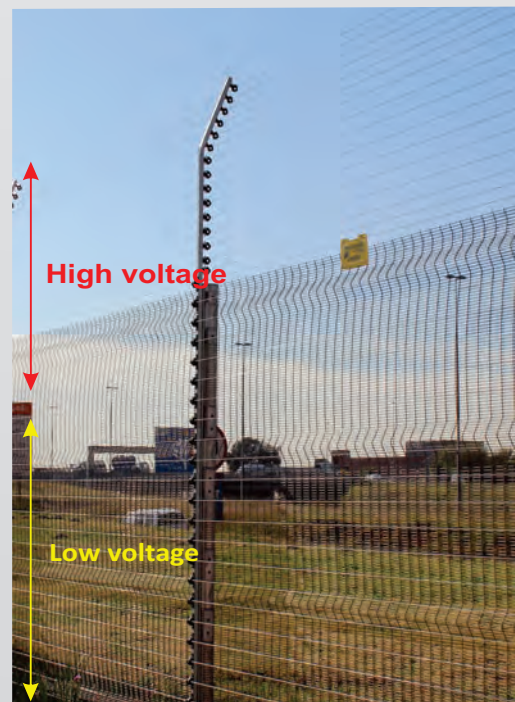

*ZLM4 Used to Make Fence
IEC 60335 / SANS 10222-3 Compliant*

JVA VM2 Vibration Detection Monitor



JPTE0342

The JVA VM2 is a Perimeter Intrusion Detection System utilizing Microphonic Cable. The VM2 (PTE0342) is designed to monitor 1 or 2 zones of Microphonic (acoustic) cable and detect attempted breaches of perimeters, by detecting the noise and vibrations created by unauthorized access or vandalism. The monitoring cables may be buried to detect digging; or attached to a fence or placed inside a wall, roof or floor, etc. to detect illegal activity.

The VM2, coupled with correctly installed cable, creates a fully monitored and zoned intrusion detection system. The VM2 has adjustable threshold and time parameters that allow the installer to tune the system to differentiate between an intrusion attempt and normal environmental sound vibrations. The VM2 complements the JVA Range of security electric fence energizers and monitors.

Features

- Competitively priced solution
- Compatible with security electric fencing (can be used adjacent to or on the same fence)
- Operates with:
 - Z-Range Keypads
 - Perimeter Patrol
 - Cloud Router®
- Detects cut or shorted cables
- Buried cable sensor system is able to monitor 2 runs of up to 300m of active cable
- Detects digging with any common tool, spade, pick, crowbar, etc.
- Able to be attached (cable tied) to palisade or mesh fencing
- Detects cutting by a power tool
- Detects hammering or crowbars separating bars
- Simple setup of sensitivity levels (threshold, event limit and window)
- Independent settings for each zone
- Can be retro fitted
- On board Wi-Fi
- Virtual Keypad™ for programming
- Cloud Router® Gateway
- LCD display
- Z-Series Keypad Bus Mk2
- IO (inputs and relays)
- Arm 1, 2
- 3 Switched 12V outputs
- 3 Form C dry contact or 12V switched relays
- Battery charger for stand-alone operation
- 12 or 24V DC operation, low power requirements
- Self-diagnostics with on-board LEDs for:
 - Wi-Fi status
 - PCB error
 - Cut or shorted cable
 - Events
 - All power fails
 - Battery power
 - Supply power
 - Relay functions

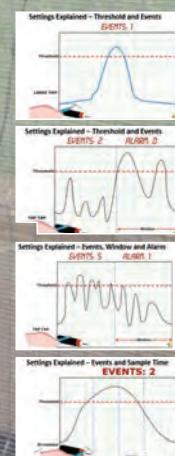
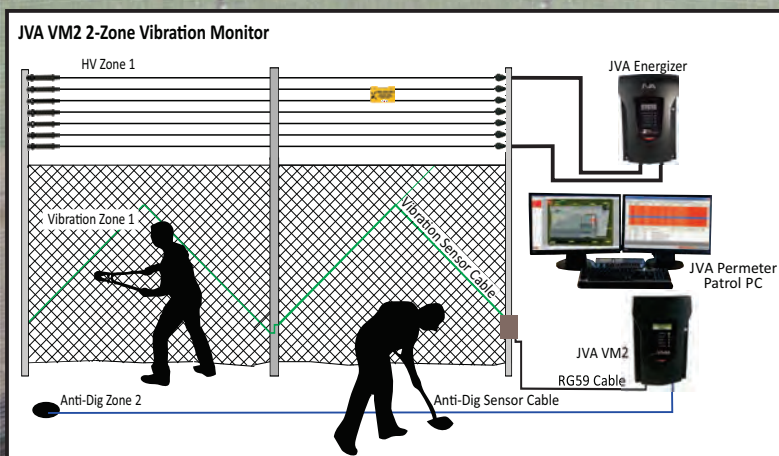

Configuration

Group ID	1
Zone 1 Threshold	25 %
Zone 2 Threshold	25 %
Zone 1 Events	3
Zone 2 Events	3
Zone 1 Window	2.0
Zone 2 Window	2.0
Zone 1 DNR	0
Zone 2 DNR	0
Battery Float	14.2 Volts
Battery Alarm	10.0 Volts
Siren On Time	0 sec
Siren Off Time	0 min
Siren Cycles	0
Auto Rearm Time	0 min
Input 1	Arm Me N/C
Input 2	Arm Me N/C
Input 3	Arm Me N/C
Output 1	Zone 1 Alarm
Output 2	Zone 1 Alarm
Output 3	Zone 1 Alarm
Emulate Mk1	<input type="checkbox"/>

JVA ZM20 and ZM50 Sector Fence Monitoring Systems



The JVA ZM20 and ZM50 are advanced security electric fence monitoring systems, enabling the partitioning of an electric security fence into 20 or 50 programmable sectors. This gives greater accuracy for detecting the locality of a fault on the fence line, which in turn allows for quicker targeted responses and/or better camera positioning.

The system is ideal when energizer placement in the field is not always possible. An energizer in one location can partition a single high voltage zone into 20 or 50 manageable sectors.

Features

- TCP/IP Connectivity with optional LAN Interface Board
- Reduces the cost of multi-zone systems
- Accurately divides a high voltage fence zone into up to 20 or 50 sectors
- Is able to be monitored via a keypad or a PC using Perimeter Patrol Software, or any Web enabled device with the addition of a JPAE225 Web Server, with e-mailed alarms; also able to be integrated into third party security management systems at a variety of levels
- Dual HV Feed, increases deterrence and reduces the effect of a cut wire
- The JVA ZM monitor can be powered by any JVA electric fence energizer
- Monitor 1–20 or 1–50 fence loops up to 8km wire length or maximum loop resistance of 1000 ohm
- 2–20 or 2–50 Programmable sectors
- Cut or bridge alarm on sudden reduction in current
- 3 Programmable dry contact control relays
- Siren and strobe switched 12V DC outputs
- Built-in charger and space for a 12V 7Ah/9Ah backup battery

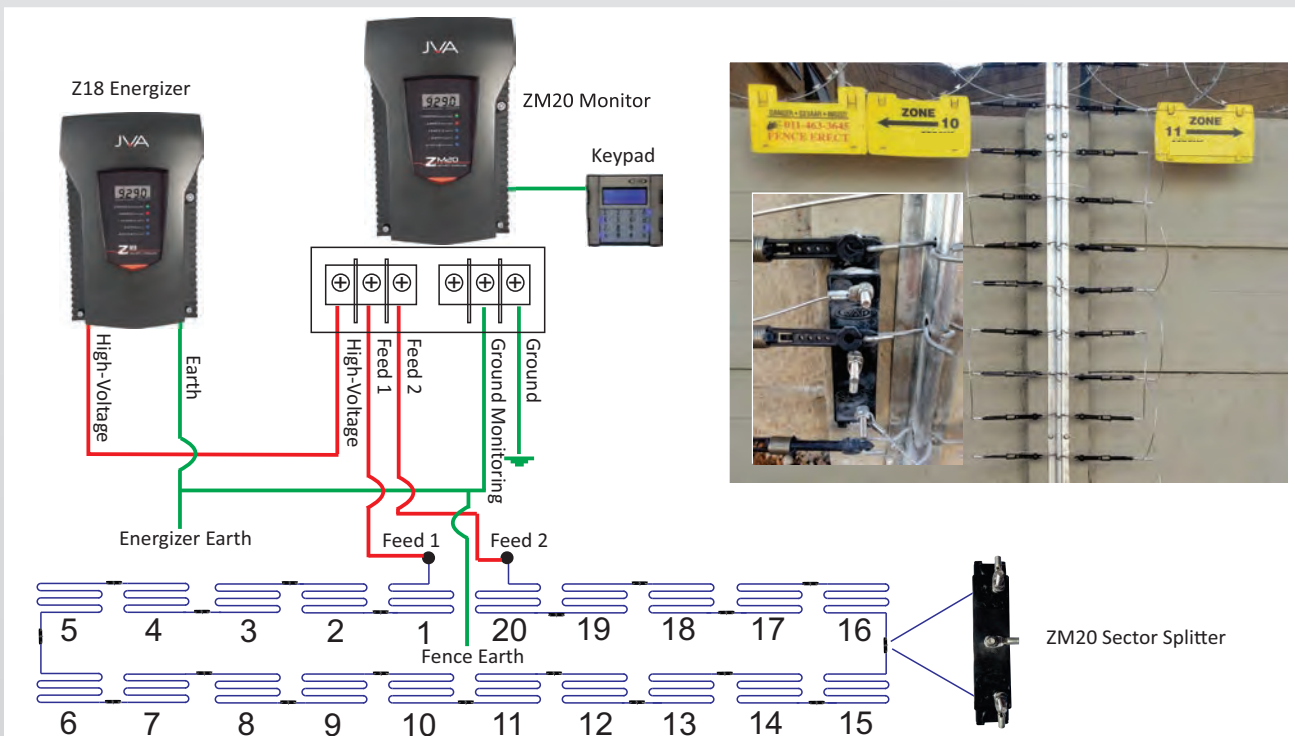

JVA ZM20 and ZM50 Multi-Zone, Multi-Sector Systems

On larger sites, consisting of multiple networked energizer stations, the ZM20s and ZM50s can further divide the individual energizer zones into multiple sectors. This improves detection as high voltage zones are broken up into smaller more manageable sectors.

The energizer stations would then, through the LAN, (Local Area Network) be networked back to the control room to the PC Perimeter Patrol Management System. Through the use of a WAN, (Wide Area Network) the JVA High Level Interface (HLI) can further integrate the system into an offsite, multiple site management system for a larger control centre setup.

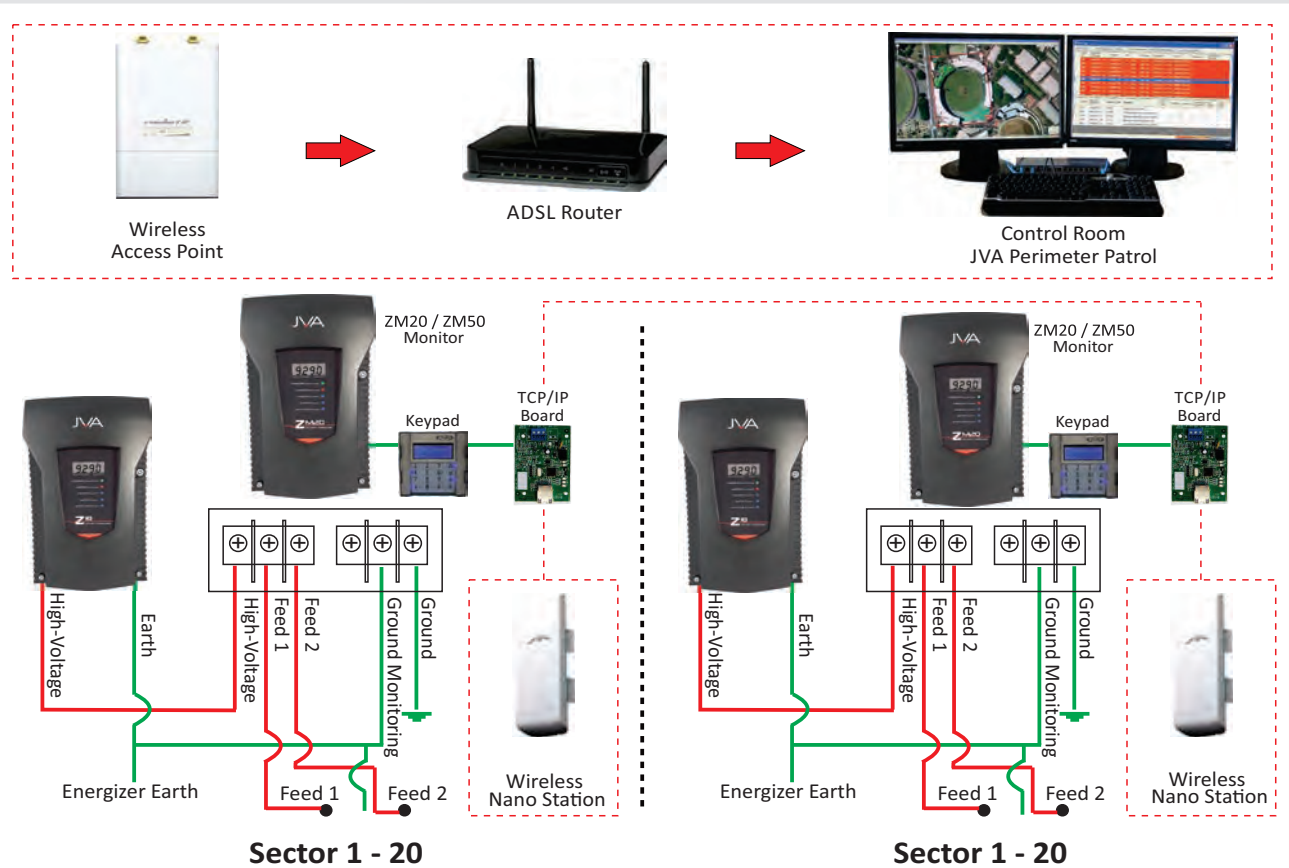

Pulse Synchronization

The synchronization of electric fence energizer pulses, powering different zones on a multi-zone electric security fence, is a necessary safety requirement to prevent someone from receiving a potentially dangerous shock. The danger arises when multiple zones, powered by different energizers, intersect each other as is often the case in urban security installations.

The zones may be electrically isolated from each other at the point of intersection. However, it is still possible for someone to touch two different zones simultaneously. Should this happen, the possibility exists that a person

will receive a shock which will be either of a greater magnitude or of a higher frequency than is safe or legal. So the purpose of synchronizing the electric fence pulses is to limit their frequency and magnitude to ensure a shock only once per pulse cycle. If energizers were able to fire a pulse, irrespective of when energizers powering neighbouring zones were pulsing, it would be possible to receive a shock at a higher frequency than is considered safe.



Synchronized System – Internal View



Synchronized System – Fence Line

For instance, in the picture below, if it were not for synchronisation, a person at point A could get shocked by fence E1 and then by fence E4 a fraction of a second later.

Synchronizing pulses also means that the magnitude of the energy passing through a person, who touches two zones simultaneously, is less than the arithmetic sum of the energy put out by the two energizers.

Thus the energy passing through the person is kept within international safety standard requirements.

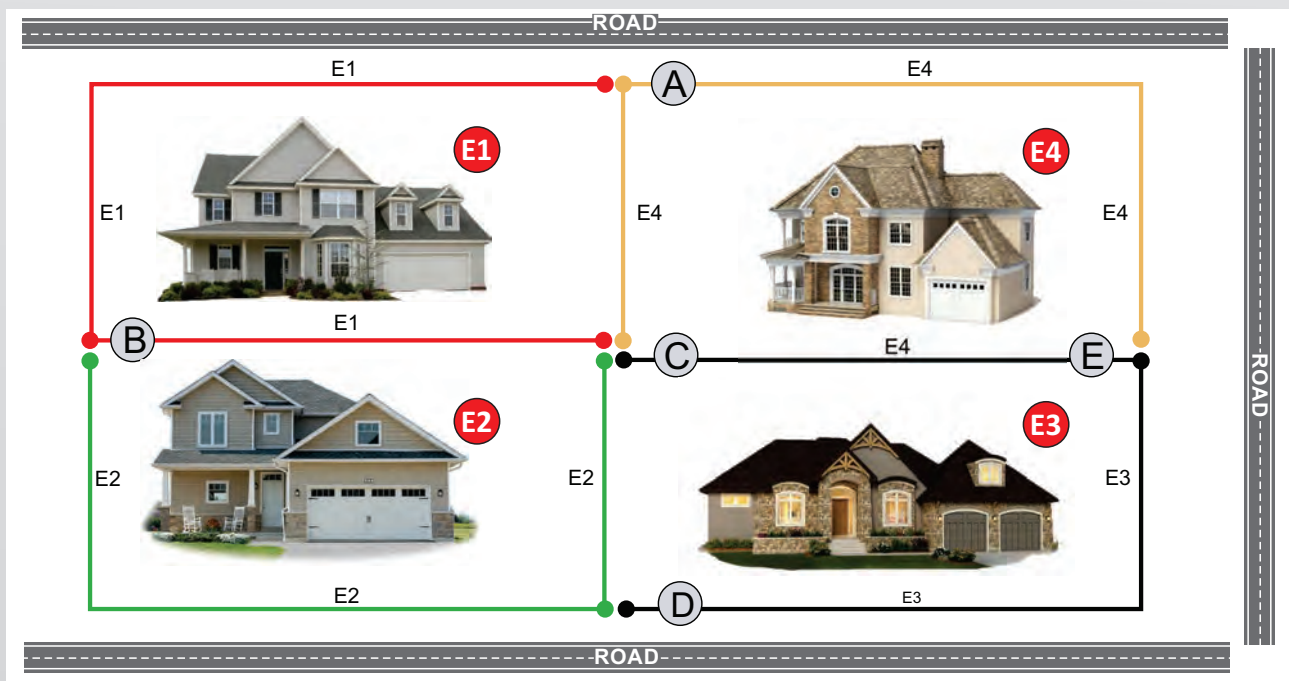

Group Synchronization Pulse Feature

In certain installations, such as walled estates, retirement villages, and large commercial and industrial complexes, it may be preferable to sectorize a fence line by installing a number of individual energizers and then linking them together into a group.

In this group mode, while the Z-Range Energizers will each power a specific sector of fence line, they will now act as one energizer by pulsing in perfect synchronization with each other, while also ensuring that the energy output of the group meets legal requirements.

Note

1. Each energizer within the group can be switched on or off individually and the group's master energizer can even be turned off without affecting the others.
2. A slave energizer will alarm if the keypad bus communication line is broken between it and the master energizer.
3. The keypad may be disconnected after programming the system, as it is not required for group operation.

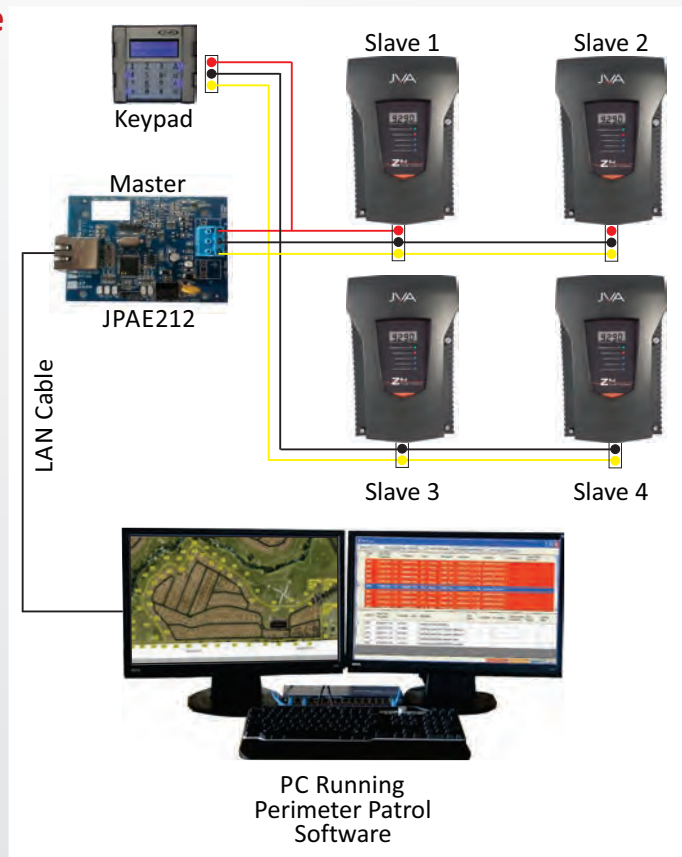

Group Synchronized System

Communication Medium

Cables using Cat5, Cat6, Fibre Optic or Wireless communication installed along a fence line, provide the communication link between JVA energizers in a synchronized group system. This form of communication enables energizers, positioned along the fence line, to communicate with, and be controlled by a central control room where voltage levels and alarm situations can be monitored and recorded on a JVA Perimeter Patrol Management System. Fibre Optic Cable or Wireless is the preferred option when long distance is required or when the site is situated in high lightning areas.



JVA GPS Sync Module

The JVA GPS Sync Module allows a group of JVA Z Series energizers, monitors and other devices to synchronize their fire pulse to the GPS network. In this way multiple groups of energizer can be synchronized without needing to link the groups by Keypad Bus or ethernet. IEC 60335.2.76 Electric Fence Energizer Safety Standards requires pulses on fences within 2.5m of one another be synchronized so as to remain safe. Simply install a PTE0345 GPS Sync Module as master on each group and they will be automatically synchronized.

Features:

- Synchronize multiple groups with no additional wiring
- Millisecond accurate time clock
- Integrated GPS receiver antenna
- External antenna possible via SMA or MLCC
- 12V supply with reverse polarity protection
- Low power, can run directly from Keypad Bus
- No configuration required
- LEDs for easy diagnostics
- Ip66 weatherproof wall-mountable enclosure



PTE0345

JVA Wireless System

Wireless communication enables transfer of information between two or more JVA devices without the need for hard wiring. The wireless transceivers operate on unlicensed frequencies of 2.4 and 5.8Ghz.

Energizers are connected to a TCP/IP interface which is then connected to the wireless transceiver via Cat5 cable. This creates a wireless TCP/IP network which can be used to transfer voltage and alarm data to JVA Perimeter Patrol Software located in a control room, laptop, smart phone or tablet. This also enables remote monitoring of fence conditions from anywhere in the world.

The use of wireless repeaters, omni-directional, 90° and 120° sector aerials, enables one to create point-to-multi-point communications that will cover a wide variety of applications. Wireless TCP/IP networks offer further benefits, namely the addition of IP devices such as IP cameras which enable the user to view and monitor the electric fence zone.

The flexibility of wireless communications allows connectivity from 1 to 40km and is a very cost effective solution. The wireless connectivity also reduces the likelihood of lightning damage to the entire system as the strike impact is isolated to the electronic equipment in the strike region only. There is no physical cable conductor for the surge to pass through to reach the entire network.

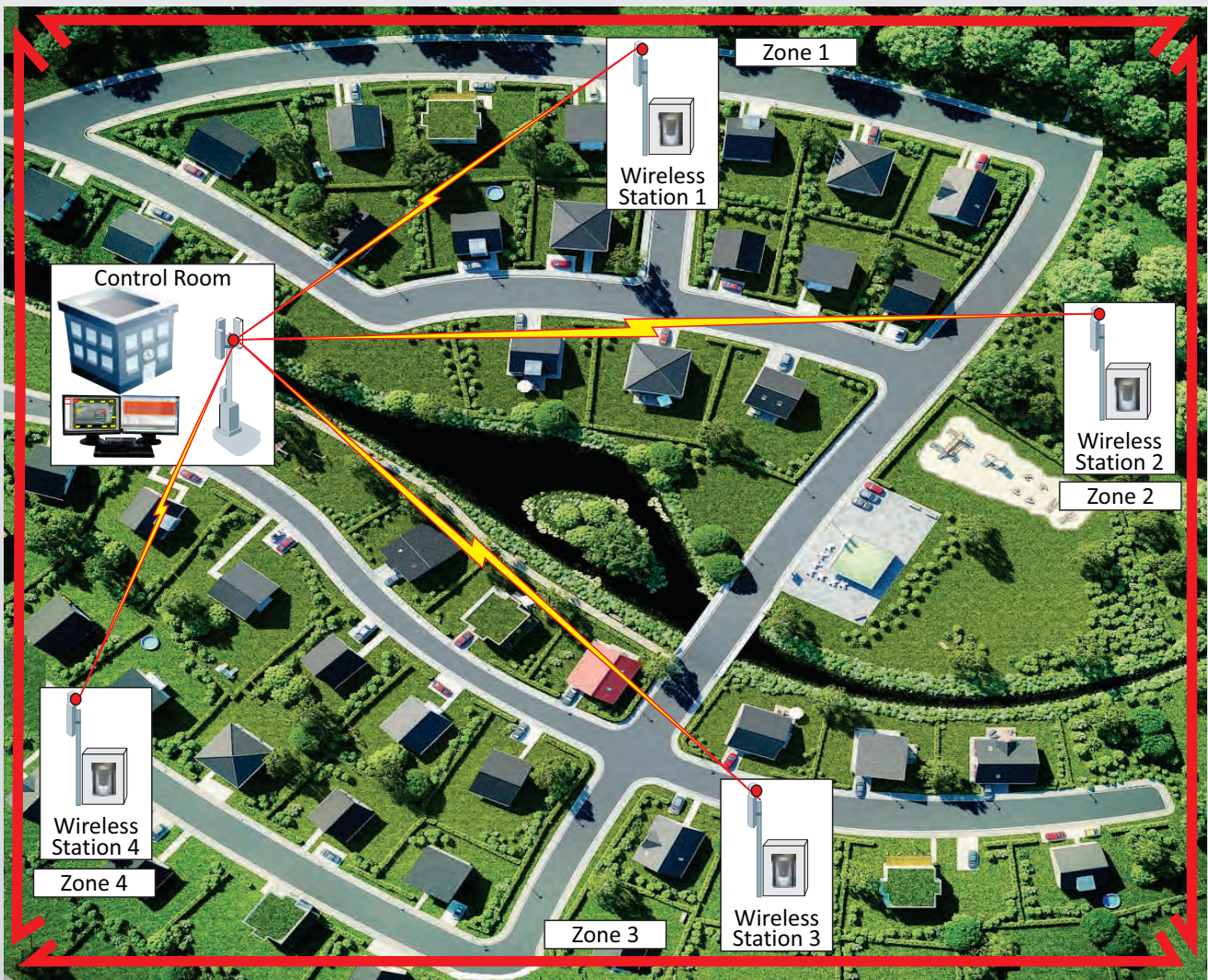

JVA Wireless Systems



Wireless Transceiver Installation



Programming TCP/IP Board



Enerizer Field Station



Programming Wireless Device



Wireless Transceiver at Control Room



Wireless Repeater at Entrance



Wireless Repeater Station

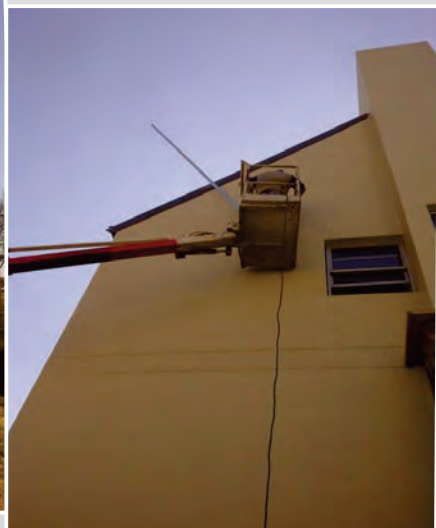

Wireless Transceiver Installation



Control Room

JVA Perimeter Patrol

This Perimeter Patrol Software is ideal for a stand-alone system, where the user requires a visual representation of an electrified enclosure (mimic screen) and the ease of operation that a Windows compatible GUI application can provide. It can also be integrated into existing systems using Cat5, Cat6, Fibre Optic Cable, Wireless Communication and Local or Wide Area Network protocols. The JVA Perimeter Patrol Software Package enables one or more energizers to be monitored and controlled from a PC.

JVA Perimeter Patrol can be used to quickly view the status and voltages of electric fences and devices; alert and email the user when the fences, gates or other devices need attention; arm and disarm electric fences according to a custom schedule and remotely access electric fence systems. Icons representing the energized zones are positioned over an image of the site map. Status and voltage information from the various zones throughout the site are updated in real time from a remote or central location. The PC speaker or external Input/Output Interface Board can be used to generate an audible alarm.

JVA Perimeter Patrol Professional



*Dual Screen
Perimeter Patrol Setup*



Google Earth/Maps Site Representation (Input)



Individual Zone/Energizer Management

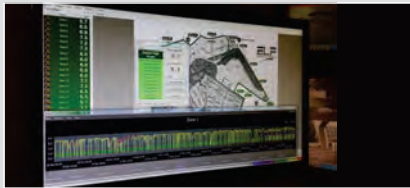

Graphical History



Group/Individual Zone Configuration page



Event Logs and Database History



Alarm and Email Configuration / management

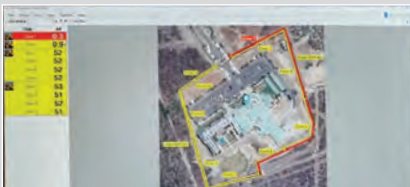

Zone/Energizer Alarm and Map Interaction



Zone/Energizer Alarm and Map Interaction



Quickview Column, Map and Energiser Status

JVA Site Monitor with High Level Interface

The JVA Site Monitor application utilises the Perimeter Patrol High Level Interface (HLI) to provide the user with one concise view of multiple Perimeter Patrol sites. This is ideal for offsite management in a central monitoring station/control room.

The HLI provides an encrypted TCP/IP data connection to transfer information between the secured site (Perimeter Patrol server) and the client software (Site Monitor). This uses a Dynamic-link library (DLL) as the gateway between the applications.

JVA freely provides a Software Development Kit (SDK) for customers to integrate the JVA suite of security products into an existing software platform. The SDK contains programming documentation and a working C# demo of a Windows Forms Application to reduce the integration time.

Site ID	Status	Value 1	Value 2	Value 3	Value 4
Z14	Armed	7.1	6.2		
Z14H	Armed	38	37	0	47
ZM20_200	Armed	0	0	0	8.2
Z14_200	Armed	8.2	8.4		

Buttons: Disarmed, Armed, Resolved, Alarmed



Client A

Perimeter Patrol Client A

Client B

Perimeter Patrol Client B

Central Control Room

Client C

Perimeter Patrol Client C

Client D

Perimeter Patrol Client D

JVA Perimeter Patrol Integration Functionality



General Purpose Input Output Board
 Monitors and Controls: 4 inputs, 4 outputs
 PIRs, temperature, pumps, water level,
 access control, beams, lights, gate control,
 camera integration.

GPIO Board
eGPIO Board – TCP/IP



Ethernet Adaptor Device
 Connected to single and multiple groups of energizers and monitors



TCP/IP Interface

Perimeter Patrol
 A powerful, flexible, intuitive user interface

Features Include

- User Authentication
- Remote Access
- Multiple Site Monitoring
- Event Logging/Archives
- High Level Interface API
- Cloud Backup
- Multiple user access levels
- Quick view screen
- Control on schedule
- Global Site Arm/Disarm
- Individual Arm/Disarm
- Export Event Logs
- Print Event Logs
- Built-in relay controller
- Integration
- Serial Comms
- Ethernet Comms
- Alarm Popups
- Map Zooming
- Custom URL (Hyperlink buttons)
- Server/Client configuration
- Alarm Escalation
- Graphical Log View

Perimeter Patrol Management Software
 Real Time monitoring of
 Energizers, Monitors,
 Cameras,
 Access Control
 and Beams



Radio Frequency Interface

Radio Frequency Interface
 Monitors and controls:
 2 inputs, 2 outputs
 Roboguards, PIRs, door sensors, beams, gates, etc.

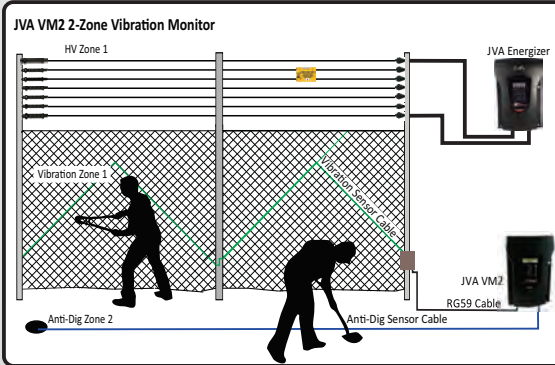

JVA Vibration Detection
 2-Zone Perimeter Intrusion Detection System utilizing Microphonic Cable that can be used above and underground.
 Total distance of 350m per zone.

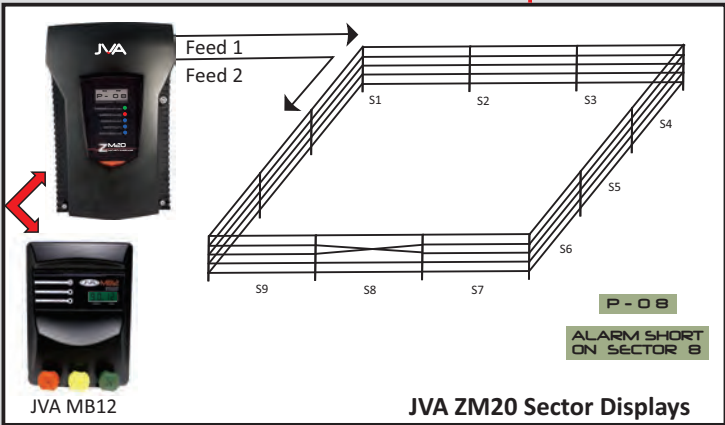

Redundancy Solution Cloud Router®

The JVA Cloud Router® provides access to your electric fence and other devices in the field through GSM and Wi-Fi. Devices are linked to the Cloud Router® via Nimbus Gateways. The Cloud Router® Solution gives a complete alternate Cloud Based Software solution to run parallel to the onsite Perimeter Patrol system giving a complete alternate offsite redundancy system.



Site Monitor (Remote)

Enables you to view multiple sites on a simple platform



Cloud Backup

Remote backup of configuration, maps, licence activation, data



Google Earth Integration

Google earth interface, Google Earth Map – import coordinates



HLI – High Level Interface

To enable remote site monitoring and customization



IOT – integration LoRaWAN – integration

TTN - The Things Network



JVA Perimeter Patrol PC

Scada Integration

Customization of Sites

Integration with VMS



SDK Software Development Kit

Enables you to view multiple sites on a simple platform

Allows customization to different platforms such as:



JVA Product Integration

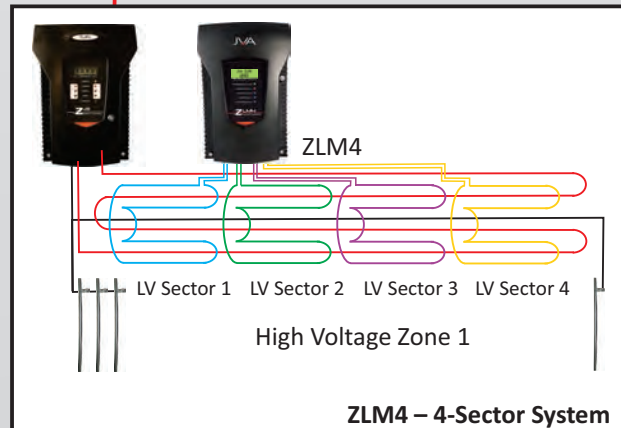
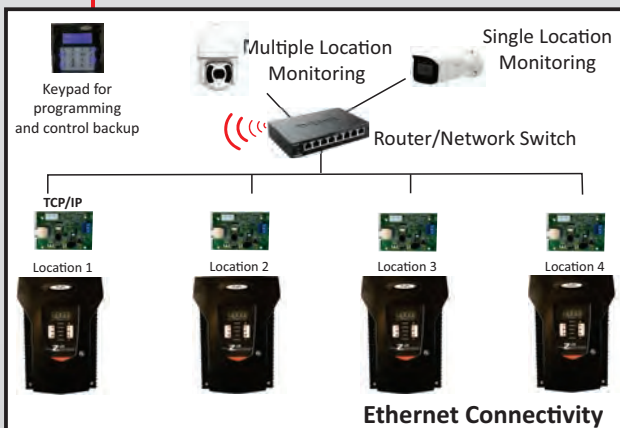

JVA Multi-Zone Methods

Basic High Voltage Stand-Alone Monitoring Options

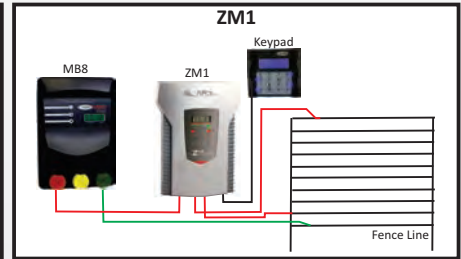
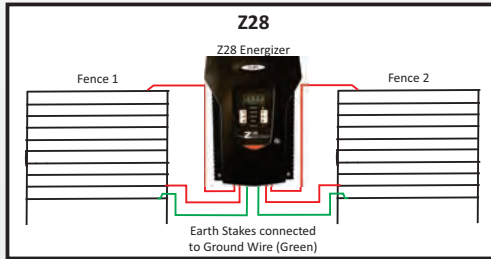
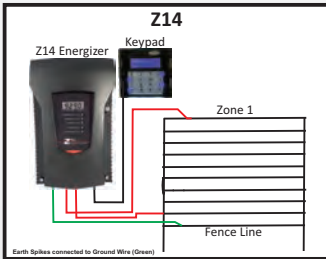

Networking

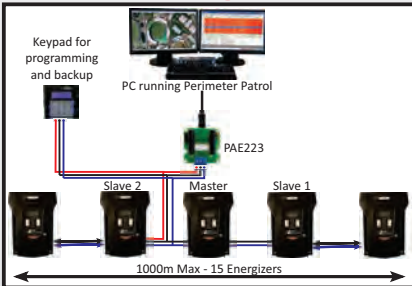

GPS Sync

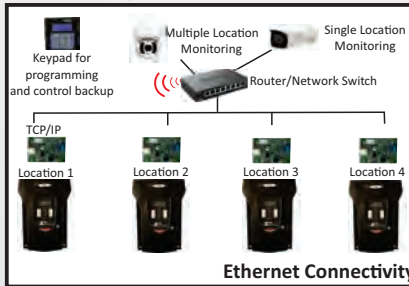

Fibre

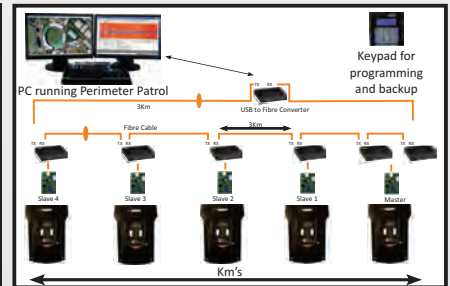

Current Monitoring

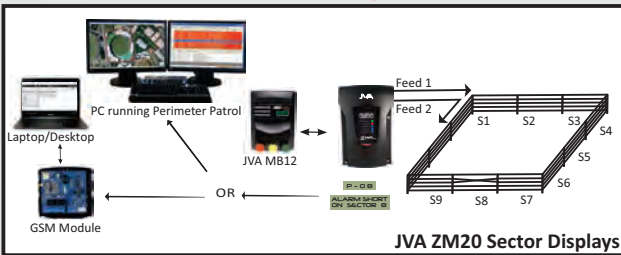

Low Voltage Monitoring

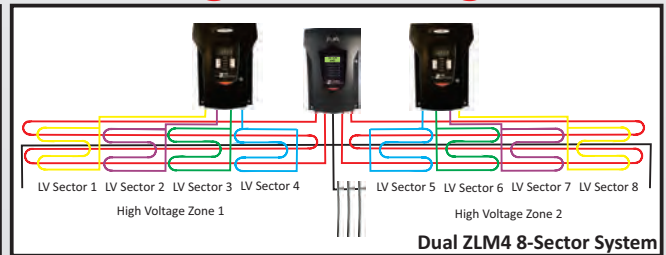

GSM or Wi-Fi Monitoring



Vibration Monitoring

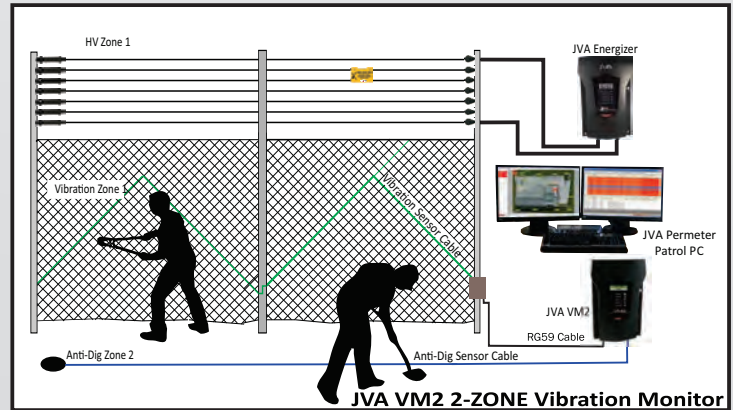

LAN Monitoring TCP/IP

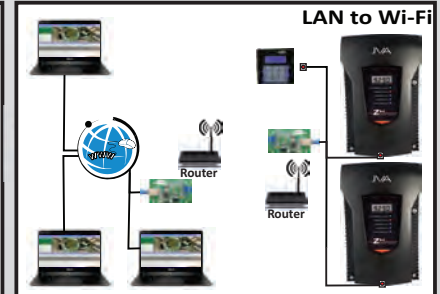
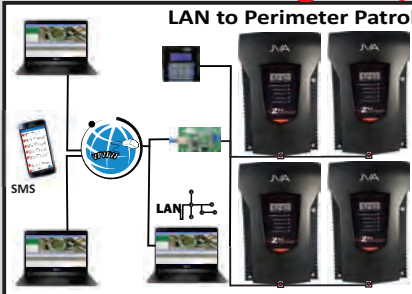

JVA Network Interface Boards

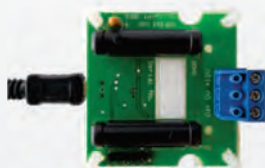

PAE223

USB Interface

The USB to keypad Bus Interface provides an optically isolated connection between the Z-Series Keypad bus and a standard USB port. A USB Interface enables control of JVA Z-Series Energizers or Monitors via a PC running Perimeter Patrol Software. The USB to keypad bus interface is required to use the JVA Firmware Flash upgrade Utility.



JP AE212

TCP/IP Board

The TCP/IP Board enables control of JVA Z-Series Energizers and Monitors via LAN and WAN using JVA Perimeter Patrol Software. The Internet protocol suite is a set of communications protocols used for the Internet and similar networks and generally the most popular protocol stack for wide area networks. It is commonly known as TCP/IP, because of its most important protocols: Transmission Control Protocol (TCP) and Internet Protocol (IP).

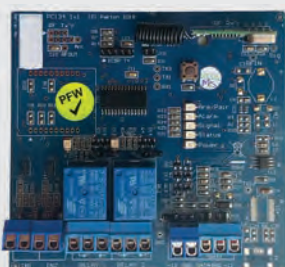

JP TE0236

JVA RFI Board

The JVA RFI Interface Board is designed to monitor wireless security devices on the 433MHz radio frequency and integrates the information into JVA products such as the JVA Keypad and the JVA Cloud Router.

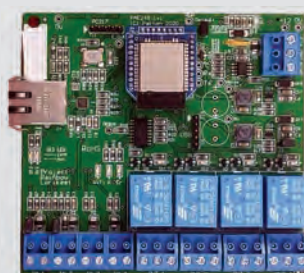

JP AE248

GPIO

The JVA GPIO adds functionality to the JVA Perimeter Alarm System. It provides stand-alone inputs and outputs to easily integrate external equipment into the JVA Software Solutions. The 4 inputs can monitor either Digital or Analogue devices such as motion detectors, IR beams, temperature sensors, and water level indicators, while the 4 outputs can be used to turn on security lighting, sirens or water pumps.

The GPIO provides an Ethernet or 2.4GHz Wi-Fi gateway between Perimeter Patrol or Cloud Router and up-to 14 Z-Series Energizer or monitors. Configuration of the GPIO is made simple through the JVA Virtual Keypad using the customer's mobile phone, tablet or laptop.



JP AE253

Wi-Fi Gateway / Cellular Gateway

The JVA Gateways allow for communication between the JVA Cloud Router and a group of Z-Series Energizers, monitors and accessories, enabling remote access and monitoring of your devices from a smart phone, tablet or PC. The Gateways feature an intelligent bandwidth-conserving protocol to ensure the Cloud data remains up to date while reducing data usage.

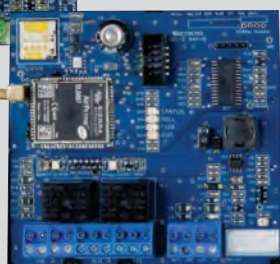

JP TE0320







Wi-Fi Gateway – does not contain input/output integration

Cellular Gateway – contains 2 inputs and 2 outputs

GPIO Gateway – contains 4 inputs and 4 outputs

JVA GSM and Wi-Fi Cloud Router® Gateways

JVA's GSM and Wi-Fi module is compatible with all the JVA range energizers. The module is designed to interface seamlessly with JVA's own internet platform and application to allow the end user to monitor and control his electric fence energizer. More specifically, the end user may login using his personal username and password to configure the module to do the following:

<p>JVA GSM Module</p>  <p>PTE0320 4G</p>	<p>JVA Wi-Fi Module</p>  <p>JPAE253</p>	  <p>Real-Time Notifications. Monitor your sites history with the event log</p> <p>Get email and SMS notifications of alarms as and when they happen.</p>	 <p>Site Sharing</p> <p>Share your sites with others, with user access controls</p>	 <p>See the State of your Sites at a Glance</p> <p>The overview page shows you the overall armed state of your site and whether there are any active alarms.</p>
--	---	--	--	--

Features:

- Real-Time Notifications – get email and SMS notifications of alarms
- Site Sharing – share your sites with others, with user access controls
- Monitor Site's History – easy search history of events and who had access
- Status of your sites at a glance – will tell you if a site is off line or whether there are active alarms
 - Power supply to energizer
 - Feed and return fence voltages
 - Tamper conditions
 - Gate statuses
 - Battery condition
- Clean, crisp, User Interface on all JVA Devices – displays information you need, whether on your mobile or desktop PC
- A single GSM unit can be connected to up to 14 Z- Range devices
- Two Output Relays (30V DC 8 amps) GSM Module
- Two Inputs – dry contact or active pull down, GSM Module
- Micro Sim Card required GSM Module
- There are 3 user levels, *Admin/Supervisor/User*
- By using a JVA ZM1, any energizer brand can be brought into the cloud management system.



! The JVA Cloud Router App provides real-time push notifications of alarms as and when they happen.



Control and Monitor your sites from the palm of your hand, anywhere in the World. With the touch of a button you can see what is happening and share with family, friends or colleagues.

Share your sites with others with granular permissions that you control.

View the state of your sites at a glance. Monitor the sites' history using the events logs.

Clean, crisp user interface on all of your devices.



NO MONTHLY CHARGES FOR PUSH NOTIFICATIONS OR APP USAGE



JVA Electric Fence Management Devices

JVA Directional Volt Meter

The JVA Electric Fence Fault-Finder is a 3-in-1 tool designed to display fence voltage, current and lead the user quickly to the location of the fault on an electric fence.

Features

- Built-in voltage and current meters with digital screen display
- Simple-to-use, one-touch operation
- No wires or clips means no tangles or shocks
- Brightly illuminated arrows indicate fault direction
- Automatic pulse polarity recognition – will operate accurately with any brand of energizer
- Gives low battery warning if the battery needs replacing
- Positive location gives more accurate and steady current readings
- Can be used in all weather
- Is made to withstand tough environments
- Commonly available battery that is easily replaced by the user
- Backlit display



SA - A301
AUS - PTE0129

JVA Digital Volt Meter

Features

- Essential for accurate testing of fence and energizer earth systems
- Readings from 100V to 10 000V
- Solid state circuitry designed for durability and rugged use
- Automatic on/off
- Replaceable 9V battery with a life of 12-18 months
- Large clip for attaching to the earth wire.



JPTE0311

Fence Beeper

Economical Keyfob Tester, which, when held in close proximity to a working electric fence, responds with a loud beep.



JVABEEP

JVA Remote Control Kit

The JVA Remote Control Kit is used for arming and disarming with dedicated arm and disarm buttons.



JPTE3001

Fence Nite Lite

Features

- Flashes with every fence pulse
- Visible for up to 100m at night and 20m by day
- Seven high bright LEDs for long life and extra brightness
- Continuous monitoring – no reset required
- Designed to be connected between live and earth fence wires
- Stainless steel connecting wires
- Reduce fence voltage by up to 0.3kV
- Sealed weatherproof unit – no maintenance or batteries required
- Can be placed anywhere on the fence
- Available in various colours



Electric Fence Applications

Domestic Applications

Aesthetically pleasing electric fences provide security and peace of mind for:



Retirement Villages



Residential Complexes



Private Dwellings



Condominium, Panama

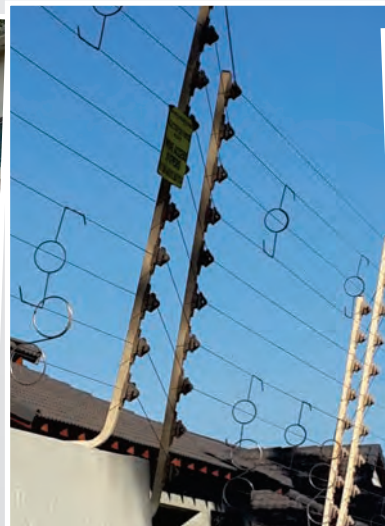

Housing Estates



Holiday Homes



Housing Estate, Control Rooms



Golf Estate



Building Apartments

Commercial Applications

Monitored electric fences are being used extensively on commercial sites to protect company assets and personnel:



Vehicle Parks



Wholesalers



Office Blocks



Garages



Vehicle Impound Facilities



Factories



JVA Perimeter Management Systems

Industrial Applications

No site too big. No site too small. From communication towers to large industrial complexes, monitored electric fences are proving the ideal solution for:



Industrial Parks



Vehicle Storage Yards



Solar Farms



Agricultural Dealerships



General Industrial Plants



Trucking Companies



Communication Towers



Factory Complexes



Petrochemical Refineries

Pirates in for a Shock

Hundreds of JVA Z14 Energizers have been purchased by major shipping companies, plying the African shipping lanes to protect their ships against pirates. A simple cantilevered barrier, erected around the ship's deck, is proving highly effective in preventing pirates from boarding their vessels at sea. The barrier is also an effective deterrent to would-be thieves when the ships are docked in a harbour.



Around the World with JVA



Domestic Security in Las Pinas, Philippines



Prison Security, South America



Installation Team, Papua New Guinea



JVA Delegation to Moscow



Security Fence Installation, India



JVA Security Installation, Africa

Around the world with JVA (Continued)



Residential Fence, Pakistan



Estate Fence, Hartbeespoort (SA)



Prison Fence, Kimberley (SA)



Domestic Fence, Kyalami (SA)



Prison Fence, USA



Chicken Farm, Swaziland



Domestic Fence, Panama



Commercial Fence, India



Estate Fence, Midrand (SA)



UN Embassy, Senegal



Vehicle Storage, UK



Farm Security, SA



Security Fence, Santiago



Container Depot, NZ



Power Station, Chile



Petrol Storage, USA



Residential Fence, Johannesburg (SA)



Petro Chemical Plant, Nigeria

Free-Standing Poles, Posts & Standards

JVA Y-Standard Round Hole



- This strong, custom manufactured, Y-Standard has larger holes punched through it to take the plastic Pop-Em and JVA Y-Standard insulator
- With the Pop-Em insulator, the wires run through the Y-Standard which makes it difficult to separate the wires apart
- Available in 2.4m and 3m lengths and in black or galvanized

Y24JVA - 2.4m
 Y3JVA - 3m
 Y24GJVA - 2.4m Galv
 Y3GJVA - 3m Galv

Rolled Profile Standard



- This lighter, electroplated or hot-dipped, galvanized profile pole can be used with Pop-Em or Y-Standard insulators
- Supplied in 1mm or 2mm thick rolled
- Can be used to reinforce palisade, or as a light, intermediate, free-standing standard
- Available in 1.8m to 3m lengths

EY1800 - 1.8m
 EY2100 - 2.1m
 EY2400 - 2.4m
 EY3000 - 3m



JVA 3-Way Profile Spacer
 UV Stabilized Plastic

N695

Security In-line Posts & Stays



- JVA Electric Fence Centres stock fully galvanized 96mm x 2mm poles
- Available in 2.4m and 3m lengths
- The poles are drilled with 1 hole at 100mm intervals along the post for S-hooks
- The posts are used for in-line straining, at starting points and gates

Y023P - 2.4m Single Hole
 Y024P - 3m Single Hole

Security Corner Poles & Stays



- JVA Electric Fence Centres stock fully galvanized 96mm x 2mm poles
- Available in 2.4m and 3m lengths
- The poles are drilled with 2 holes at 90° with 100mm intervals along the post for S-hooks
- The posts are used to turn corners

Y023PD - 2.4m Double Hole
 Y024PD - 3m Double Hole

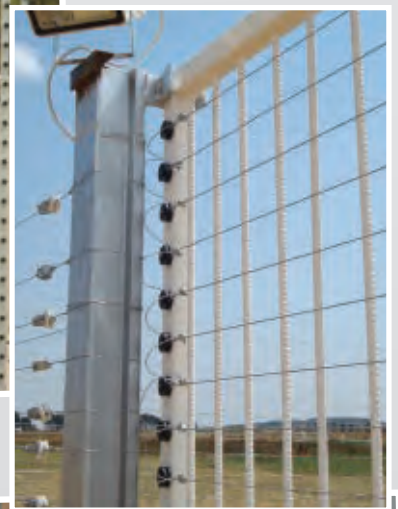

Wall-Top Brackets

JVA South Africa has a well-equipped steel fabrication factory and powder-coating plant. These facilities enable us to quickly and economically manufacture our standard, or custom-designed, wall-top brackets. Wall-top brackets can be either hot-dipped galvanized or powder-coated depending on a customer's requirements. JVA Security Centres can also custom manufacture aluminum or stainless steel, wall-top brackets. Customized orders require approximately 7 working days for completion. All JVA Security Centres hold a wide variety of wall-top fencing brackets in stock at all times.

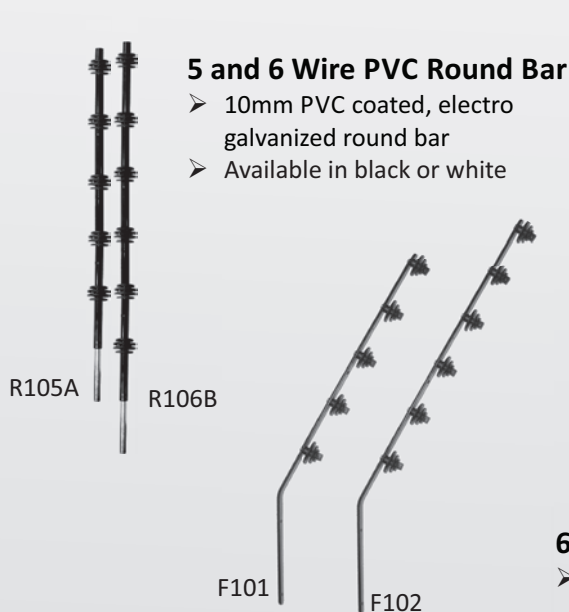

5 and 6 Wire PVC Round Bar

- 10mm PVC coated, electro galvanized round bar
- Available in black or white

R105A R106B

F101 F102

5 and 6 Wire Flat Bar

- 20mm x 5mm flat bar wall-top brackets
- Available in straight or angled, black or white powder-coated or HD galvanized



5 and 6 Wire Profile Bracket

- For use on flat topped walls
- Angled profile for added security
- Bracket is fitted with base plate for secure attachment to the wall
- Manufactured in flat bar or square tube
- Available in black or white powder-coated or HD galvanized



600mm and 750mm Stays

- 8mm round bar stays are used to stabilize strain and corner wall-top brackets
- The stay can be supplied as is, or with a lug welded onto it
- Available in black or white powder-coated or HD galvanized



5 and 6 Wire Round Bar

- 10mm HD galvanized or powder-coated round bar
- Fitted with 5 or 6 bobbin insulators
- Very economical and easy to fit
- Available in black or white

6, 8 and 10 Wire Square Tube

- 20mm square tube wall-top brackets for the more quality conscious installer
- Brackets can be fitted with black or white Pop-Em, Flat-Bar or Nail-On insulators
- Available in straight or angled, black or white powder-coated or HD galvanized

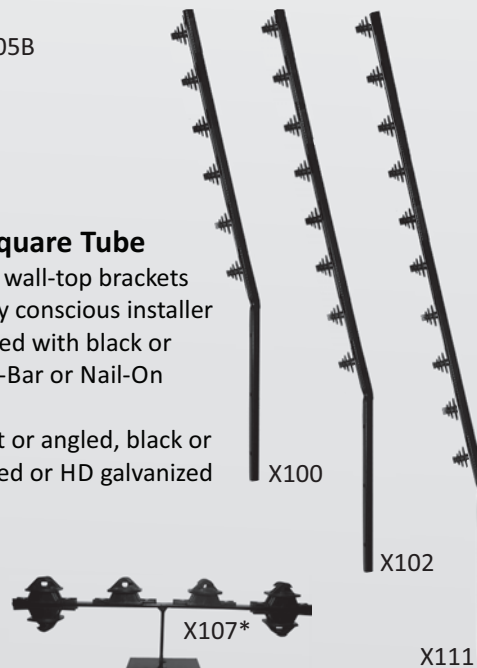

6 Wire T-Bracket

- Ideal for an unobtrusive fence on top of a high wall
- Available in black or white powder-coated or HD galvanized

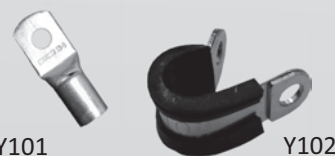

Y101

Y102

Lug and Stay Clamp

- This lug is fitted to one end of a stay to facilitate attaching the stay to a wall
- The stay clamp is used to attach the top of the stay to a round bar bracket

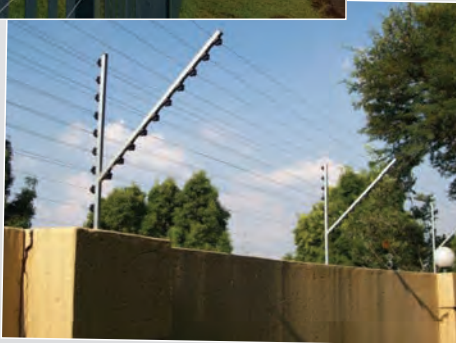
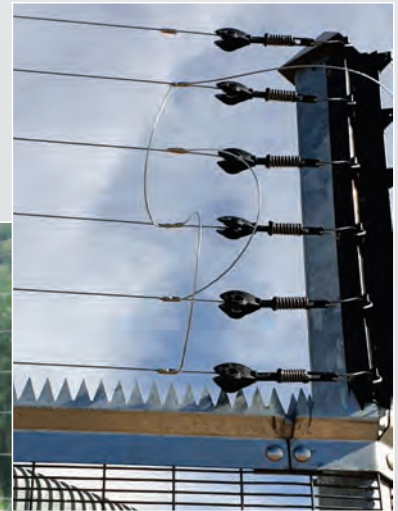

JVA Coastal Range of Nylon Polymer Profile Brackets



The JVA R&D team has solved one of the worst problems faced by home owners in coastal areas. Salt deposits on electric fences can lead to arcing and false alarms, not to mention rusting and failure of metal fittings. The solution is our new range of extruded and moulded nylon polymer (NP) brackets.

These state-of-the-art extruded profile brackets can be used to reinforce palisade and are ideal for matching and reinforcing modern, welded mesh, clear view type fencing. The insulators clip easily into place and can be used with a variety of wiring configurations.



JVA Extruded Profile Standards

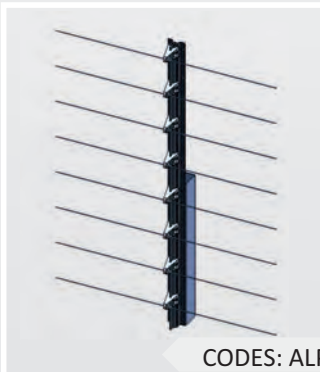

CODES: ALP4 – ALP30

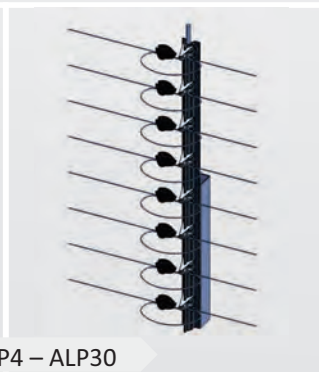

CODES: ALP4C – ALP30C



JVA EPS Intermediate Profile

This bracket can be used as an intermediate post with the N902 Intermediate Insulator and N908 Pin fitted. It can also be used as a straining post in conjunction with N902S Strain Insulators and N908 Pins. When used as a strain post, it is recommended that the profile be reinforced with 1mx10mm lengths of 304 grade, stainless steel rod inserts, to strengthen the post further when under tension.

Available in: 4,6,8,10,18,21,24 and 30 wire spacings.

JVA EPS Corner 90° Profile

This bracket, used in conjunction with the N902S Corner Strain Insulator, is the ideal straining point for the inside of a 90° corner of a conventional, square-tube fence post.

The post can be further reinforced with 1mx10mm lengths of 304 grade, stainless steel rod.

Available in: 4,6,8,10,18,21,24 and 30 wire spacings.

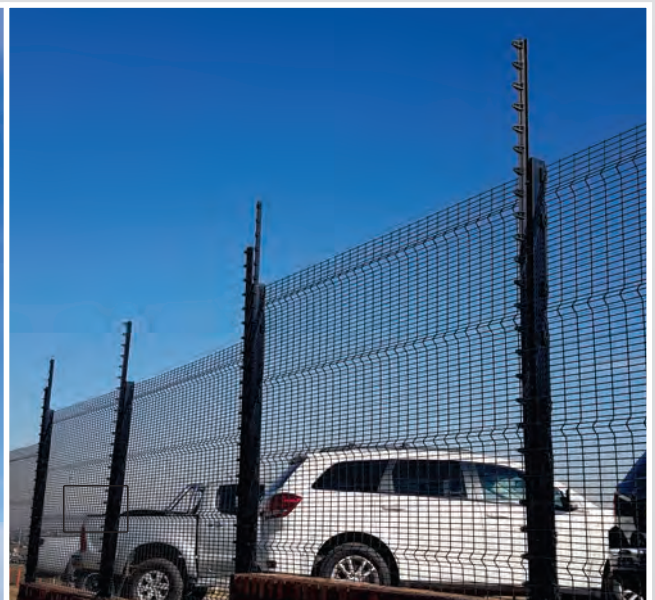

JVA Coastal Range of Nylon Polymer Wall-Top Brackets

The JVA Nylon Polymer, Moulded Wall-Top Brackets with their unique, patented mounting bracket, provides multiple installation solutions for wall-top fences. The JVA nylon polymer moulded wall-top bracket arms are available in 6, 7, 8 and 10 line variants but can also have additional lines added at 50mm spacings to increase security. Purchased in sufficient quantities, these bracket arms can be colour coded to match the wall. The range also has a 6-wire T-Post, with spacings for earth wires under each live wire. Available ex-stock in black in number of strands as per table.



Installing Angled Bracket Fencing

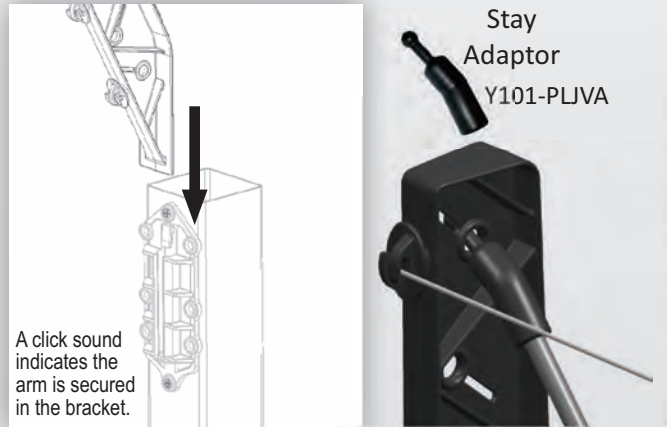

Available in Strands:

	5	6	7	8	9	10
Option 1		x	x	x		x
Option 2	x	x	x		x	
Option 3		x	x	x		x
Option 4		x	x	x		x
Option 5		x	x	x		x

Option 1
Mounted angled on the inside of a wall using the reverse mount bracket

6 Strand (X100PLJVA)

XPLMB-L

Reverse Mount Bracket

Option 2
Mounted vertically on the inside of a wall using the reverse mount bracket

6 Strand (X103PLJVA)

XPLMB-L

Reverse Mount Bracket

Option 3
Mounted vertically on the outside of a wall using the small bracket

6 Strand (X100PLJVA)

XPLMB-S

Small Bracket

Option 4
Mounted angled on the outside of a wall using the small bracket

6 Strand (X100PLJVA)

XPLMB-S

Small Bracket

Option 5
Mounted horizontally on the top of a wall using the small bracket

6 Strand (X107PLJVA)

XPLMB-S

Small Bracket

Options Available to Strain a Wall-Top Fence

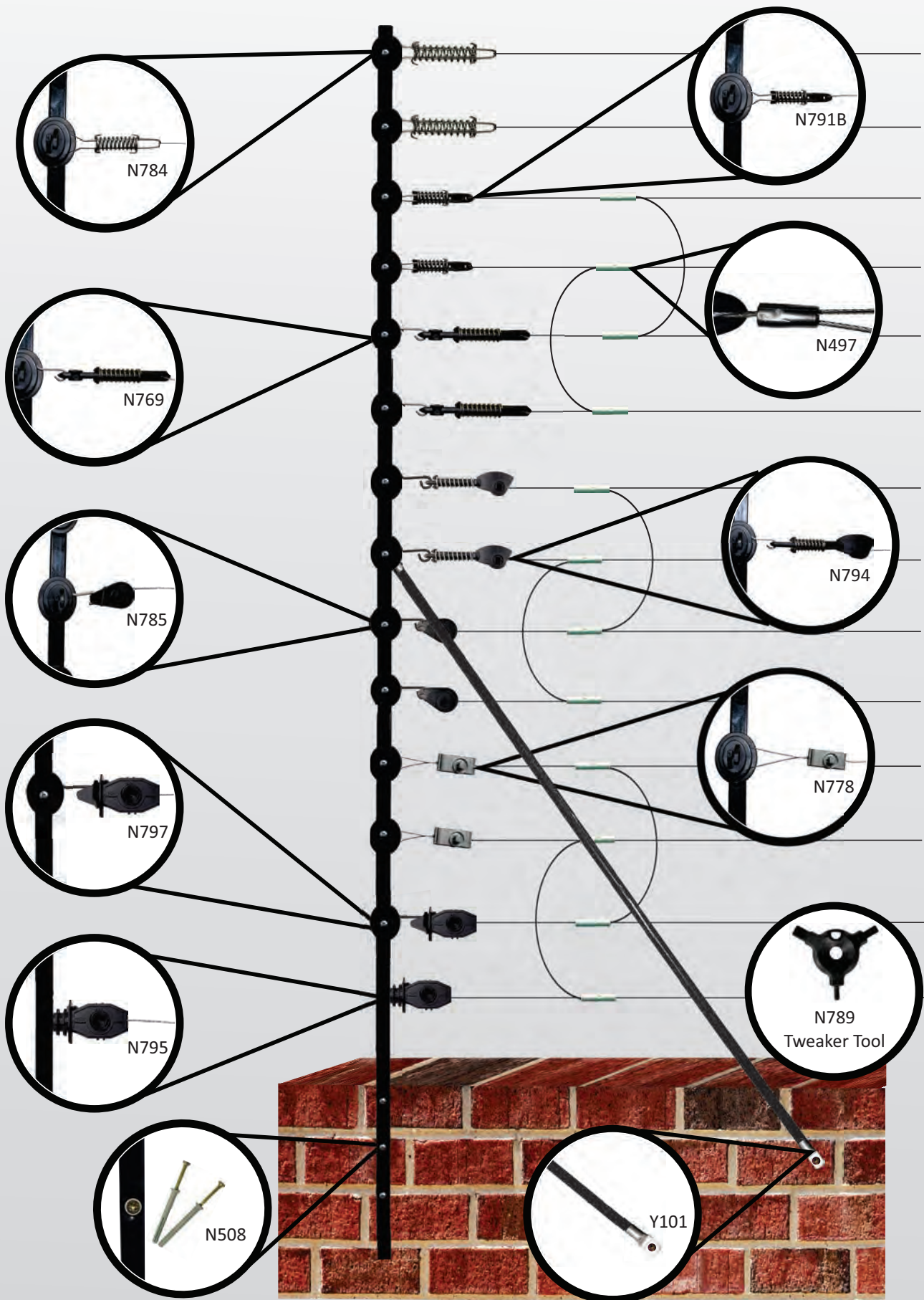

Tensioners

Wall-Top Wire Tentioners (1mm - 1.6mm wire)



N784



N791B

Security Spring

304 Stainless Steel
and Nylon



N769



N769QR

Compression Nylon Spring

304 Stainless Steel



N779D



N778

Mini Donza

Galvanized or
304 Stainless Steel



N785

JVA Mini Nylon Tweaker

Ideal for coastal
installations



N795

Midi Tweaker

Nylon flush-mount
for walls and square tube



N794

Mini Tweaker Combo

304 Stainless Steel
and Nylon



N797

Midi Hook Tensioner

Nylon 1mm - 1.6mm wire



N786

Maxi Tweaker

Strong Nylon quad
securing tensioner
1.6mm - 2.2mm wire

Free-Standing Fence Wire Tensioners (1.6mm - 2.24mm wire)



N770P

Plastic Combi

Hot-Dipped Galvanized
or 304 Stainless Steel



N771

GFT Combi

Hot-Dipped Galvanized
or 304 Stainless Steel



N771P

Porcelain Combi

Hot-Dipped Galvanized
or 304 Stainless Steel



N760

Atlas

Hot-Dipped Galvanized



N790

Mini Tweaker S-hook 3mm



SP009

HD Plastic Combi

Heavy Duty Galvanized
for 2.5-3mm wire



SP025

HD Atlas

Hot-Dipped Galvanized
or 304 Stainless Steel



N781

Combi & Jumbo Strain S-hook

6mm Hot-Dipped
Galvanized or Stainless Steel



N788

Maxi Tweaker S-hook 4mm



N777

Spring hook 2.5mm

Line Clamps

Ensure good electrical connections



N499

Ferrule
4mm



N500

Ferrule
6mm



N721

Mini
Mech Galv



N741

Standard
Mech Galv



N742

U-Bolt
Mech Galv



N740

Standard
Hot-Dipped



N742HDG

U-Bolt
Hot-Dipped

JVA Electric Fence Tamper Switch

Type A – Wall-Top



Type B – JVA Profile



The JVA Tamper Switch is a simple, clever patented product designed to be fitted to new or old fences, to detect when a live wire on an electric security fence line is being tampered with.

This tamper switch will then trigger the fence line voltage monitor which in turn will trigger an alarm (siren, armed response, security lights, etc.) to warn the occupants of a property that their perimeter is being interfered with. (The electric wire may have been cut or forced apart.)

The Switch has adjustable disks that can set the sensitivity of the tamper. Ideally the switch should be centered between two spring loaded tension points. The switch can be retro-fitted to Flat Bar and Square Tube fencing using the Type A Plate and to JVA Profile and JVA Y-Standards using the Type B Plate. Multiple Switches can also be used on one post.

Multiple switches can be added in a single strand if higher security is required (see bottom strand below). The switch can be used on HV and LV fencing. The susceptibility to wire movement can be made very sensitive on low voltage fences (ZLM powered), where the arcing of high voltage is less of an issue. It is important to make sure that the post to which the Tamper Switch is attached is earthed to ground.

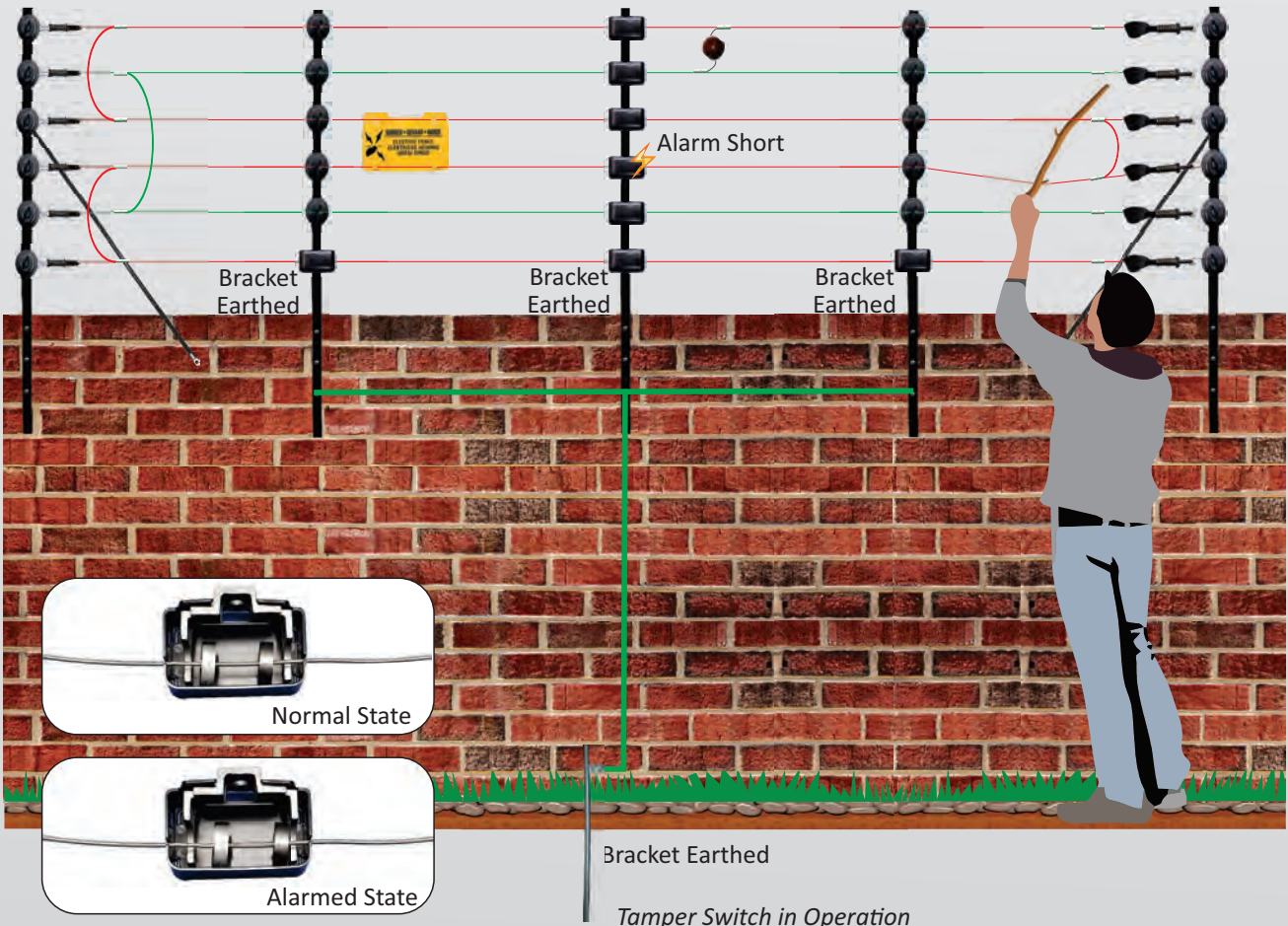

Insulators

Strain Insulators



N679

Jumbo Plastic Strain
UV Stabilized Plastic

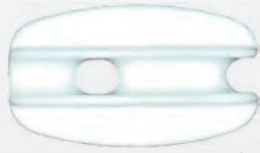

N678

Jumbo Strain Security
Hardened plastic for higher tensioning



N681

GFT Strain
Glass fibre, DMC
Fire Resistant



N676

Porcelain Bullnose Strain
Fire-proof

Intermediate Insulators



N671

Plastic 10mm Round Bar Bobbin
UV Stabilized Plastic



N683A

Gate Strain and Combi Bobbin
UV Stabilized Plastic



N687

Porcelain Bobbin
Fire-proof



N686

N685

Large and Small GFT Bobbin
Glass Fibre, DMC
Fire Resistant



N673E

Export Nail-On
UV Stabilized Plastic



N673

Nail-On
UV Stabilized Plastic



N690

Y-Standard
UV Stabilized Plastic



N690JVA

JVA Y-Standard
UV Stabilized Plastic



SMBOB

Smart Bobbin Black
UV Stabilized Plastic



N689B

Anti-Twist Flat Bar Bobbin
UV Stabilized Plastic



N691

Pop-Em 19 — 25mm
UV Stabilized Plastic



N691-2P (50mm)

HD Pop-Em 25 — 55mm
UV Stabilized Plastic



SP001

Pin Lock
UV Stabilized Plastic



N521

GFT Buzz Bar
UV Stabilized Plastic



N698S-SL

N698SL

Ring Insulator LD
Square tube or Wall-mount screws supplied separately

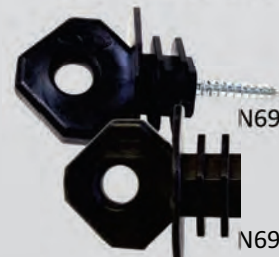

N698S

N698

Ring Insulator HD

JVA Taut Wire Monitoring Solutions

Keeping two steps ahead of criminals is JVA's aim and forte. As criminals become more proficient and fence tampering and bypassing become an issue, so we develop increasingly sophisticated monitoring systems to thwart their efforts.

Closer intermediate posts, narrowing the wire distance between lines and shorter strain distances all help to contribute to an effective physical fence structure. However, there is still a need to reinforce old fences and for more high-tech, anti-tampering devices to monitor new strategic fences.

While traditional methods such as High Voltage and Earth Loops are effective, JVA offers the Inline Tamper Switch and the Genius Taut-Wire Tensioner to be used on their own or in conjunction with the JVA ZLM4 monitoring system to create an even higher level of detection on existing or new electric fences.



JVA Traditional Tamper Solutions

Earth Loops (Triggers alarm if fence wires are separated)



Bi-Polar Security SIS Series Monitor Loop
Allows for earth and live monitoring or Bi-Polar monitoring

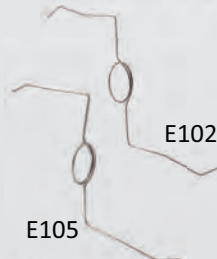

Intermediate Earth Loop
316 Stainless steel or 4mm fully galvanized



Wall-Mounted Double Earth Loop
316 Stainless steel or 4mm fully galvanized

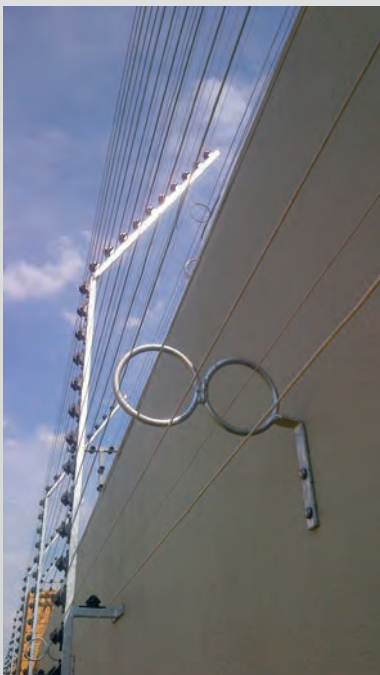

JVA Genius Taut Wire Tensioner

The JVA Genius range of tensioners are specifically designed to work in conjunction with the JVA ZLM4 monitor to detect fence line tampering. The tensioner is designed to work with 1mm to 1.6mm high strain wire.

This Patented Monitoring System will trigger an internal monitored switch if tension on the fence is released by interference such as an intruder pulling on or cutting the wires. The tensioner can be retrofitted if required.



TWGLD



TWGHD

Method 1: Taut Wire Only – Tension Monitoring Only

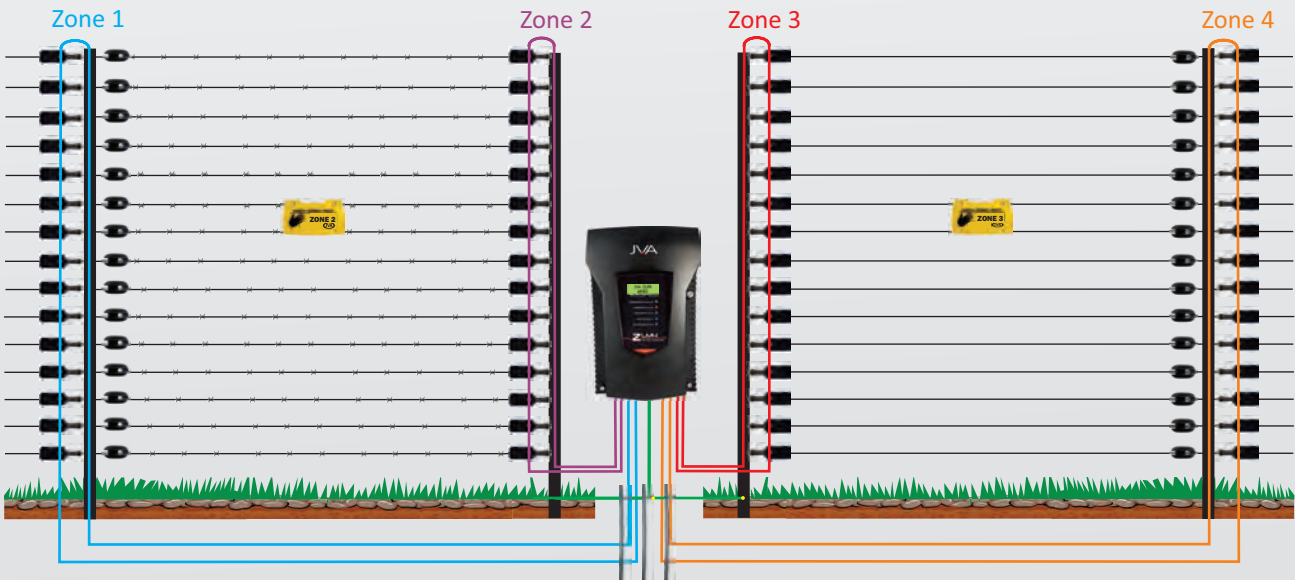

Method 2: Taut Wire and LV Fence Monitoring Together

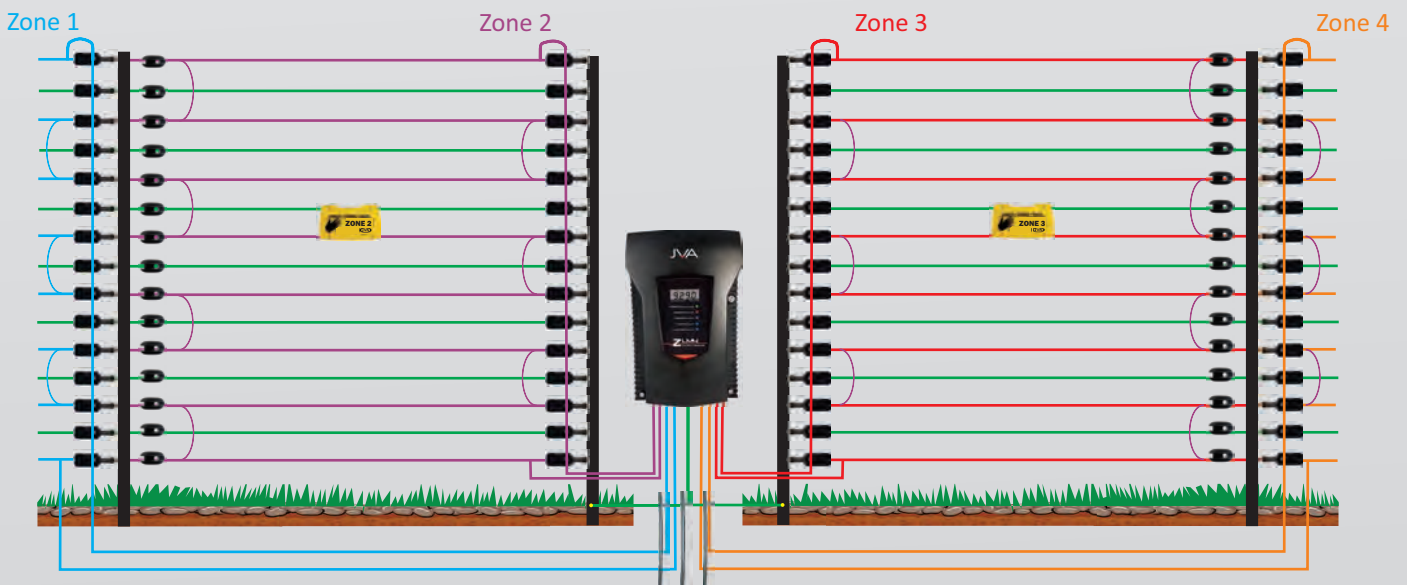

Method 3: Taut Wire and LV Monitoring Separately

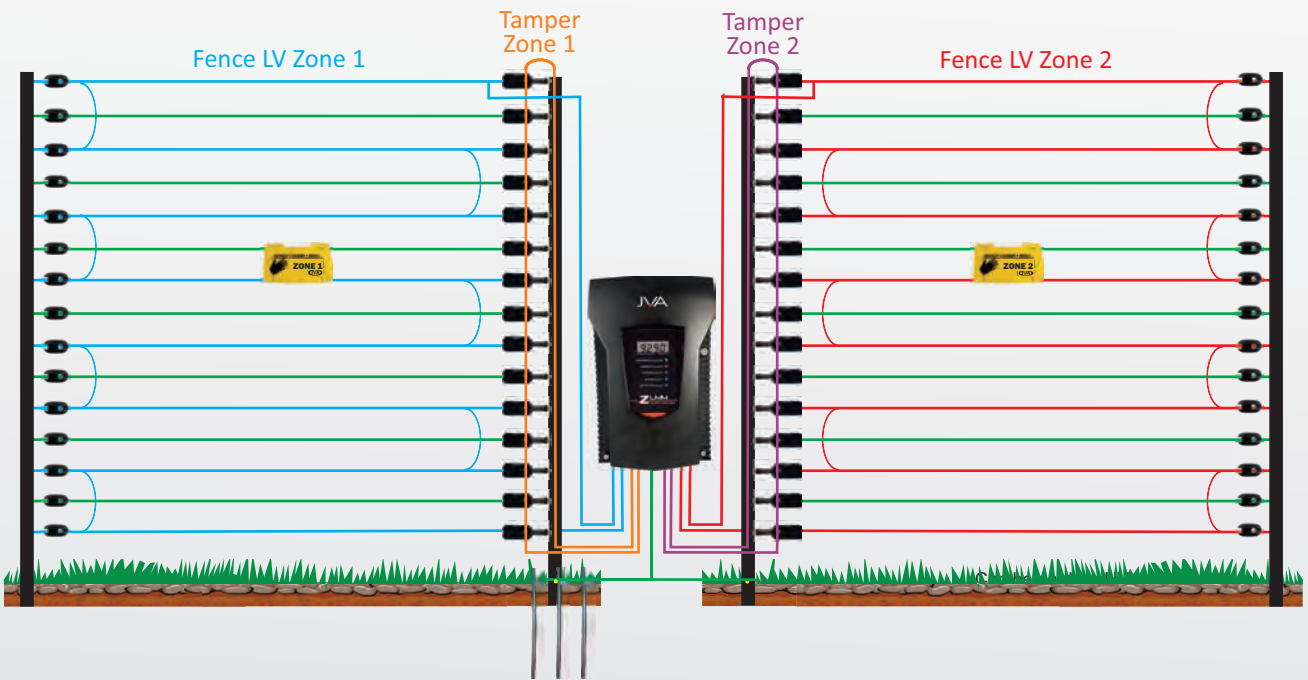

Method 4: Taut Wire and HV Monitoring Together

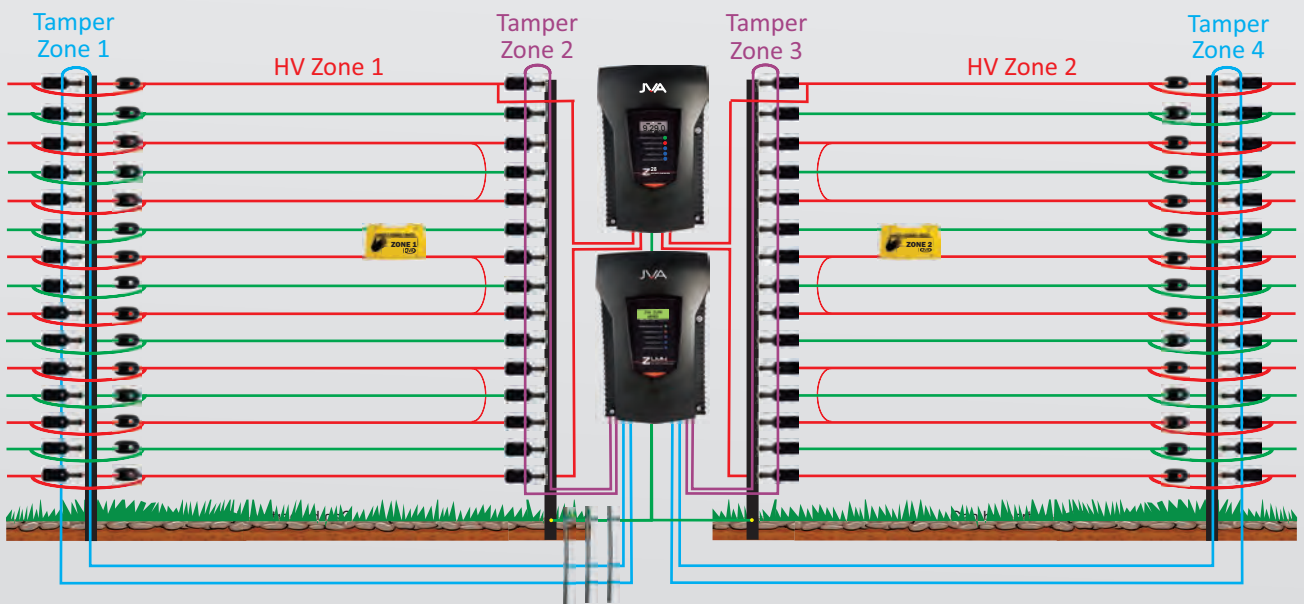

Gate In-Line Series Circuit

The diagram below illustrates a gate-top fence circuit when the gate is CLOSED. Here the gate In-Line Contact enables the gate-top circuit to be an integral part of the over-all fence circuit. Cutting the wires or interfering with the gate will break the circuit and trigger an alarm.

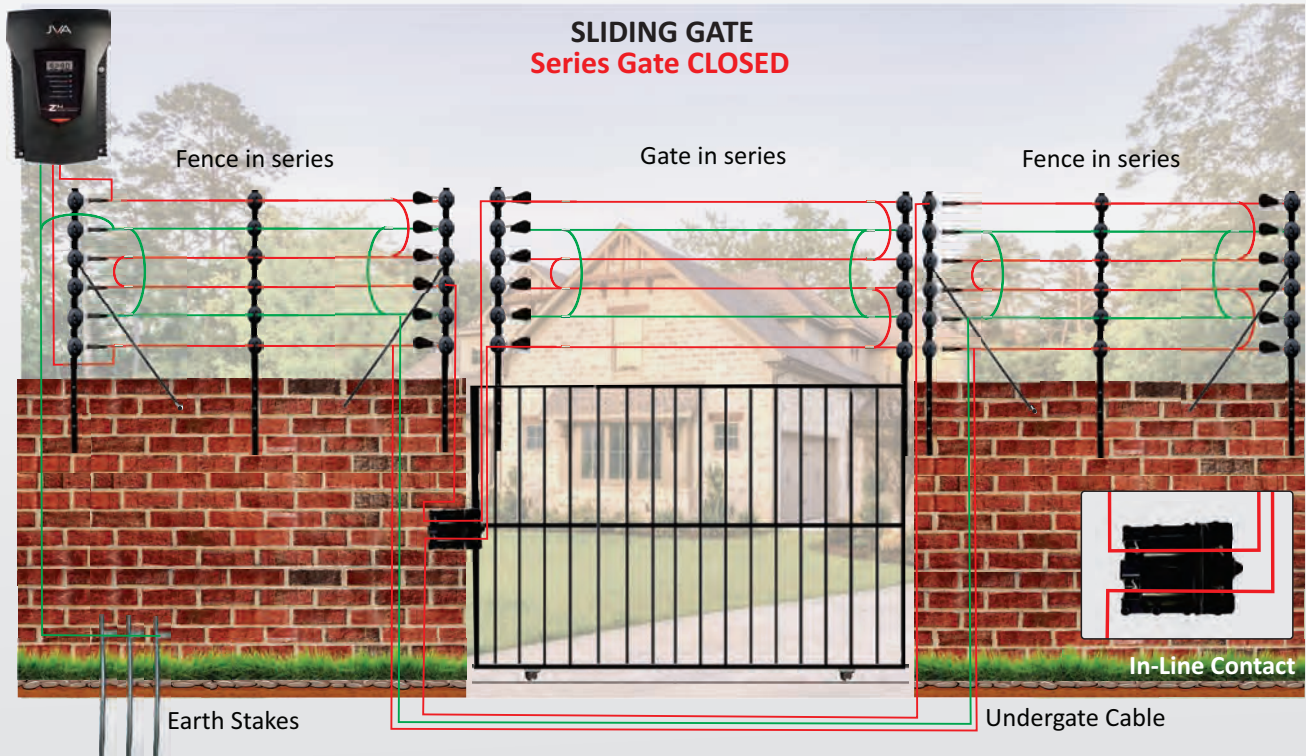

The diagram below illustrates a gate-top fence circuit when the gate is OPENED. Here the current from the fence will pass through the gate contact and under the fence to complete the circuit and allow access.

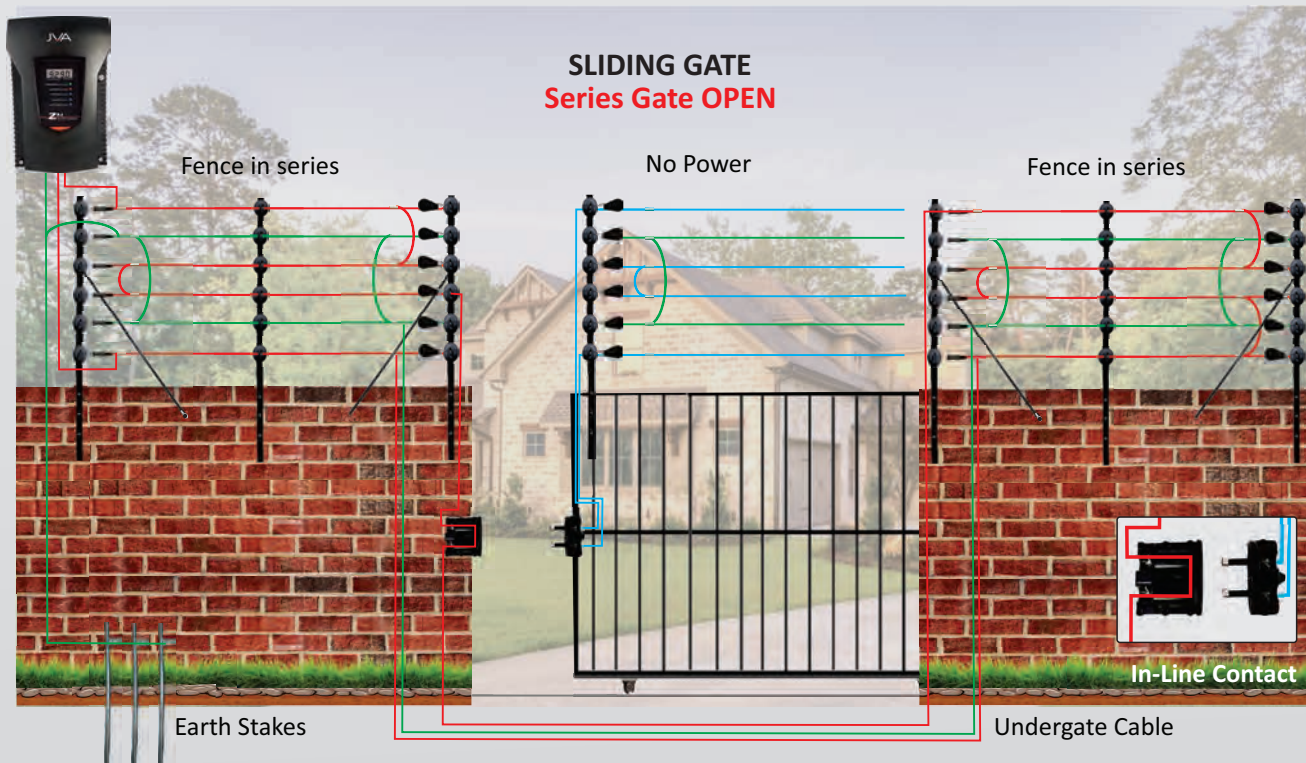

To detect an intruder forcing the gate open, a Mag Contact linked to the energizer gate alarm, can be installed to monitor the gate status.

Accessories

Warning Devices



Fence Flashing Lights



N527
Small Siren
10w/15W – 12V DC



N352 N351
Strobe Lights

Customized Signs

With a minimum order of 100 warning signs, you are entitled to personalized warning signs, with your logo and company details.



N528
Large Siren
25W/30W – 12V DC



N699
Light Duty Wall-Top Warning Sign
UV stabilized with double clips



N701
Heavy Duty Free-Standing Warning Sign
UV stabilized with double clips

Gate Contacts



N524
Standard Gate Contact



N525
Series Gate Contact



N526
In-Line Gate Contact



N526SAG
Slide-Across Series Gate Contact

Switches



S712
Lockable Cut-Out Switch



J-ZM20S
Zone Resistor



N705
Flood Gate Controller



N514
Radial Key Switch

Tools



T024
Concrete Nipper



RIC0670
Raco Mini Bolt Cutters



T002
Professional Crimper



T018
Conventional Fencing Pliers

Accessories

Earth Loops (Triggers alarm if fence wires are separated)



Bi-Polar Security SIS Series Monitor Loop
Allows for earth and live monitoring or Bi-Polar monitoring

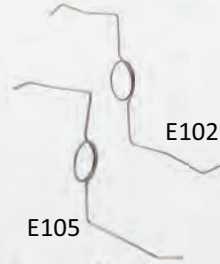

Intermediate Earth Loop
316 Stainless steel or 4mm fully galvanized



Wall-Mounted Double Earth Loop
316 Stainless steel or 4mm fully galvanized

Earth Stakes

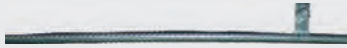

Reinforced Bar with Clamp
120cm/150cm
Hot-Dipped galvanized



Angle Iron with Clamp
120cm/150cm
Hot-Dipped galvanized



SABS with Clamp
120cm Copper-Coated

Under-Gate Cable



HT Cable Soft, Slimline
For Wall-Top Applications
Available in 50m, 100m, 200m and 1000m



HT Cable - Hard
For Free-Standing Applications
Available in 100m, 200m and 1000m



HT Cable Aluminium
Low resistance for long lead outs
Available in 200m and 1000m

Fencing Wire



Braided Wire
High tensile, low resistance
Available in 1.2mm, 1.5mm and 2mm galvanized, stainless steel or aluminium
1.2mm – 135m/kg



Aluminium Wire
Low resistance
Available in 1000m rolls in 1.6mm and 2.0mm



Stainless Steel Wire
Available in 1mm to 3mm; 304 and 316 grades
1mm – 157m/kg



High Strain Steel Wire
Full range available in light or double galvanized
2.24mm 50kg 1650m
2.00mm 50kg 2000m

Off-Set Brackets



N201
N202
N203



N210
N211



N215
N217
N212

Fencing Tools



N703



T004



N708

Enclosures



Batteries

We stock a wide variety of Battery Types and sizes.



Solar Panels

Solar panels utilize premium polycrystalline cells secured in heavy duty aluminium frames. Polycrystalline panels provide superior efficiency of sunlight to electrical current, resulting in faster charging of batteries. A full range of solar panel sizes from 40W to 305W are available.

- | | | | |
|------------|------------|-------------|-------------|
| 40W – N803 | 75W – N938 | 100W – N810 | 160W – N939 |
| 50W – N804 | 80W – N813 | 120W – N817 | 265W – N842 |
| 60W – N821 | 85W – N812 | 140W – N820 | 305W – N823 |



Lightning and Surge Protection

Lightning is the most powerful and most destructive 'natural enemy' of electric fences and while one can take precautions against it, no lightning protection kit will totally guarantee protection against a strike. However, it will considerably help reduce the risk and damage to an energizer.

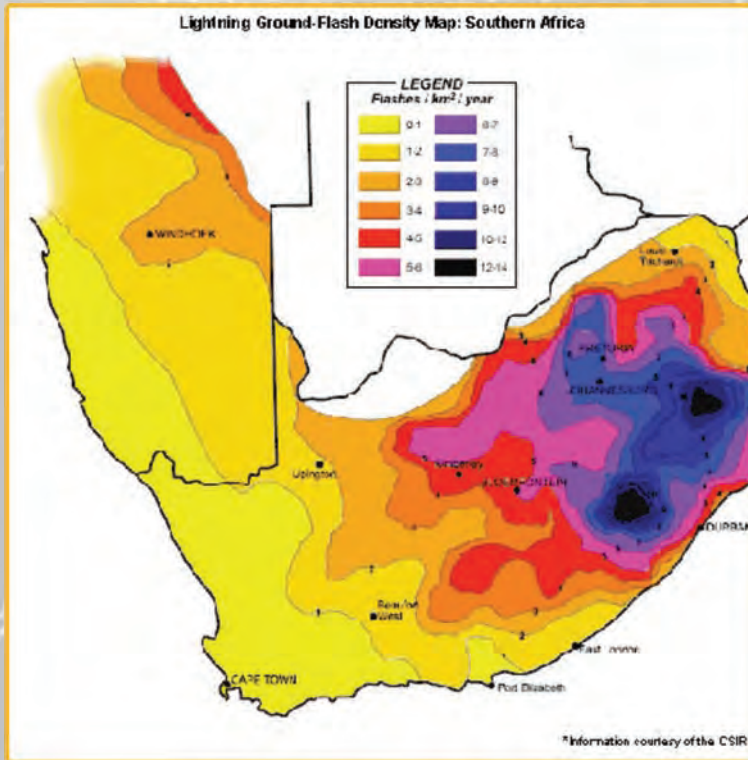

Dual Lightning diverter

At last, a lightning diverter that can handle both the feed-out and return circuits of a security energizer! Also, its 2-stage protection can withstand a lightning surge of up to 2000 Amps, limiting the voltage return to the energizer to an acceptable 15kV. This Dual - Channel Diverter is ideal for any JVA Security Energizer, especially on security fences in areas experiencing high lightning intensity.

Features

- Feed and return wiring protection
- Affordable sacrificial security component
- One diverter required for most installations
- Provides a highly visible indication of a lightning surge
- Large sturdy terminals for solid under-gate wiring
- Dust resistant design and cover for internal use only



Cover ON

Cover OFF

Fence Line Lightning Diverter

N720JVA



Cover OFF

Cover ON

Inside

The unique, V-shaped JVA Electric Fence Lightning Diverter is fully SANS 10222-3 compliant and is ideal for incorporation into lengthy agricultural and wildlife fences in areas where lightning is problematic.

Features

- Ideal for installation on long fence lines
- Choke and Arc gap built into one diverter
- Large protected terminals
- Unique V shape favours lightning's preference for shortest straight line route to ground
- Adjustable Arc Gap
- SANS 10222-3 Compliant (20KV Protection and Terminal Touch Protected)
- Water resistant design for external installation

220V Under/Over Voltage Protection Plug

In the event of an over or under mains power supply to the energizer, this product completely protects the energizer by temporarily disconnecting the energizer from the mains supply.



C016

Lightning and Surge Protection

JVA Lightning Diverter (multi-stage) Electric Fence Energizer Protection

Simple to fit and proven effective in the field over many years this device is cheap insurance for any electric fence Energizer. Easy to fit, completely sealed against the elements, this device is a true multi-stage lightning diverter, not just a cheap spark gap!



Features

- Easy to install
- Cheap and reliable way to protect your Energizer
- Contains an RFI filter to aid in reducing the electrical interference that can cause a ticking noise on telephones and inhibit the use of the Internet.

JVA Power and Signal Line Surge Protector - Z Series

The JVA Power and Signal Line Surge Protector is the must have device when installing single zone Z-Series Energizers. It provides protection for all of the low voltage connections to and from the energizer. This ensures that a lightning strike on, or near the cabling, is safely diverted to Earth. Its two stage protection can withstand a lightning surge of up to 250 Amps.



Four Channel Low Voltage Lightning Diverter - ZLM4

The JVA 4 Channel Low Voltage Lightning Diverter provides protection for a ZLM4, ensuring that a lightning strike on, or near the fence, is safely diverted to Earth. By doing this you are

protecting not only the ZLM4 but also any equipment connected to the ZLM4. Its two stage protection has been designed to withstand a lightning pulse of up to 2500 Amps while limiting the voltage to within 60V of the Earth.

Features:

- Feed and Return wiring protection
- Affordable sacrificial security component
- Easy to fit

Features:

- Protects the 16VAC, Keypad bus, inputs, Keypad bus, and Siren/Strobe outputs
- Affordable sacrificial security component
- Suitable for all single zone JVA Z-Series Energizers and the ZLM4, ZM20 and ZM1.

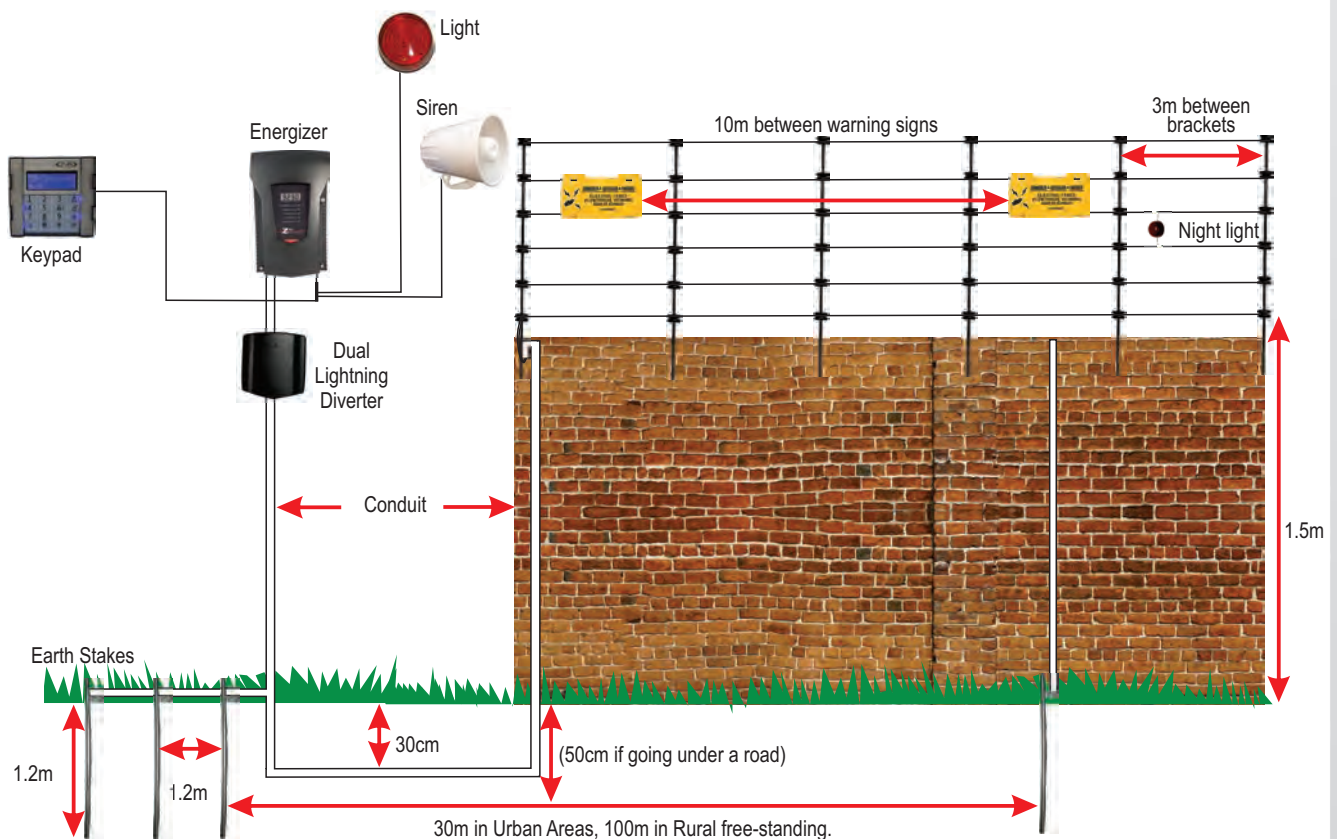

Wireless, Outdoor, Double, Wide-Angled Beams



The Roboguard is a reliable, affordable outdoor surveillance system, ideal as an add-on to any electric fence, alarm or complete stand-alone security system. The Roboguard sensor is weatherproof, tamper-proof, robust, impervious to lightning and UV damage.



Roboguard Beam

This is a battery operated, dual-sensor, outdoor movement detector designed to detect intruders and wirelessly transmit the information to a Roboguard Base station. The internal batteries have a ±2-year life span. The Roboguard dual-beam system uses state-of-the-art equipment and technology.



Portable Headquarters (HQ)

A portable 8-zone, 4-output, base-station is used to receive and announce signals from up to 8 Roboguard Sensors. The HQ can also be wired to a siren and/or alarm panel.



Alarm Interface

The Roboguard alarm interface is used to interface up to 4 Roboguards with individual intruder detection, tamper and status LEDs.



Power Pack

The HQ interfaces with external devices such as a siren and/or alarm panel. It is a complete solution with a 7A/h battery, 16V DC transformer, tele-cable, DC power to HQ and 5 relay out-put PCBs.



Receiver

A separate receiver provides the data stream for the Keypad and for the repeater station.



Transmitter

A Roboguard Transmitter is capable of transmitting roboguard intruder and roboguard remote alarms in response to triggering from externally connected systems.



LED

The LED Driver unit is used to indicate visually the status of the Roboguard system. The status is indicated via an add-on LED. LED indicates *Armed*, *Disarmed* or *Alarm* conditions.



Keyfob Transmitter

A handheld, remote transmitter is used as a panic button and remote control for radio base-stations. 4-button and 6-button versions are available.

Quick, Simple, Reliable Effective Perimeter Surveillance



Features

- Roboguard uses state-of-the-art equipment and technology.
- The portable Headquarters (base station) can monitor up to 8 sensors at once and will give both an audible and visual alert of the exact sensor that is triggered.
- The Headquarters has an internal rechargeable battery pack. The unit can operate directly off mains power and has a 24-hour backup for portable use.
- The units have internal batteries which have an approximate 2-year life span.
- The Headquarters monitors any tampering with the sensors, as well as battery levels.
- The Roboguard sensor is weatherproof, tamper-proof, robust and impervious to lightning and ultra-violet light damage.
- The basic kit includes a Headquarters and one sensor. Additional sensors – ‘guards’, can be added up to a maximum of 8.
- Roboguard sensors are available in black, green or white.
- No digging, no cabling, no trunking

Unique benefits:

- A. Fanned beams range over a wide area
- B. Dual beam eliminates false alarms

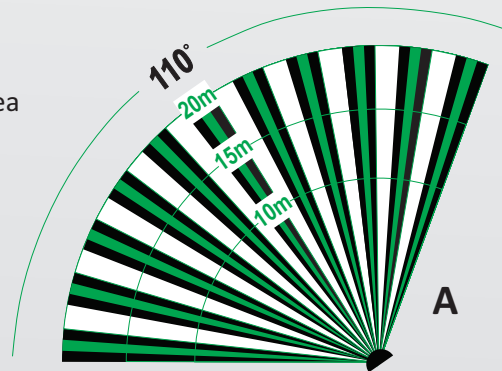

Applications include:

Houses, driveways, carports, gardens,
pools, caravans, game spotting, factories,
store rooms, farms, chicken houses, stables.



JVA RFI Interface Module

Compatible with Roboguard

This Australian designed and manufactured device is highly reliable and boasts the following features and benefits.

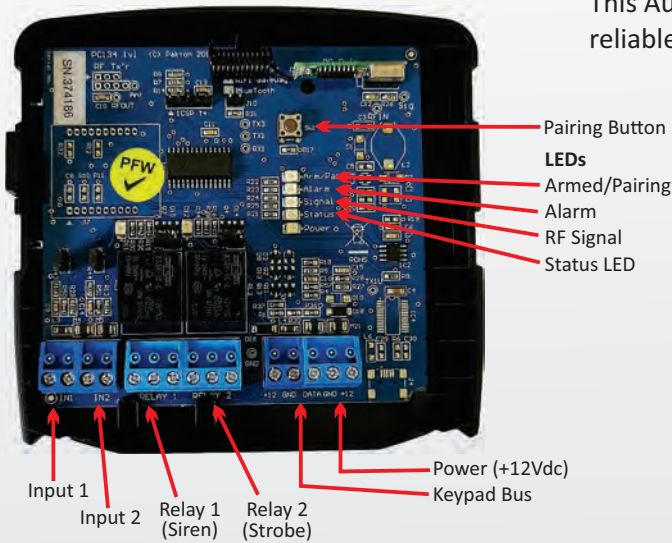

Features

- Can monitor up to 8 wireless zones
- Can monitor up to 2 wired zones (sacrificing 2 wireless zones)
- Can be paired with up to 20 remotes
- Alarm reporting for each zone – through a User Interface
- Programmable Options – easy to customize the device to suit varying site requirements
- 2 programmable function relay outputs

Frequency range

- 150m – Roboguard Detectors
- 60m – PIR Detectors
- 40m – Remotes

A Roboguard Repeater might be required for larger sites or improved signal strength.



JVA Android Keypad Configuration

Program the Roboguards into the JVA RFI via the program button or the JVA Android Keypad. Arm and disarm the system via a JVA Remote or Roboguard Remote or JVA Android Keypad. When a Roboguard detects motion, the RFI will trigger the siren and strobe outputs and the zone name will display on the JVA Android Keypad Mimic screen. Zones can be named for easier identification.

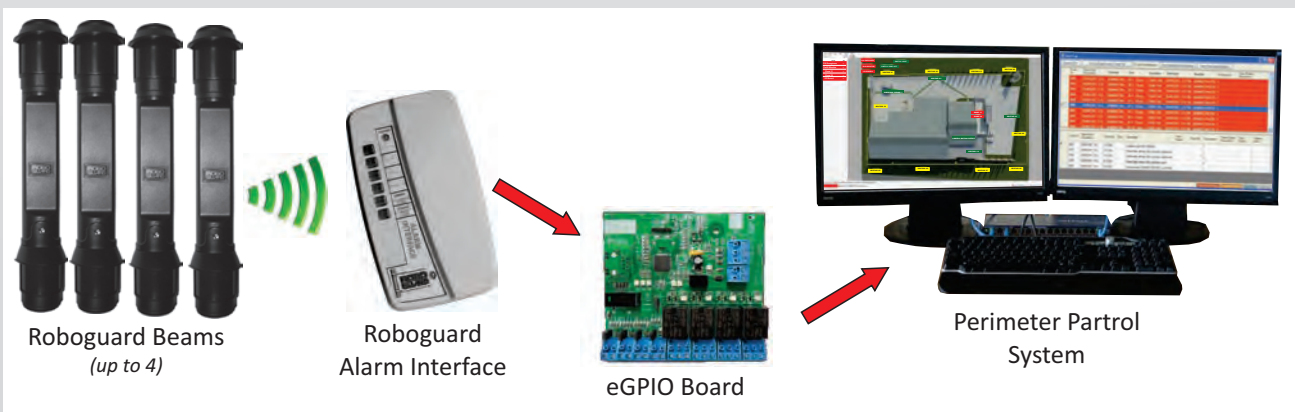
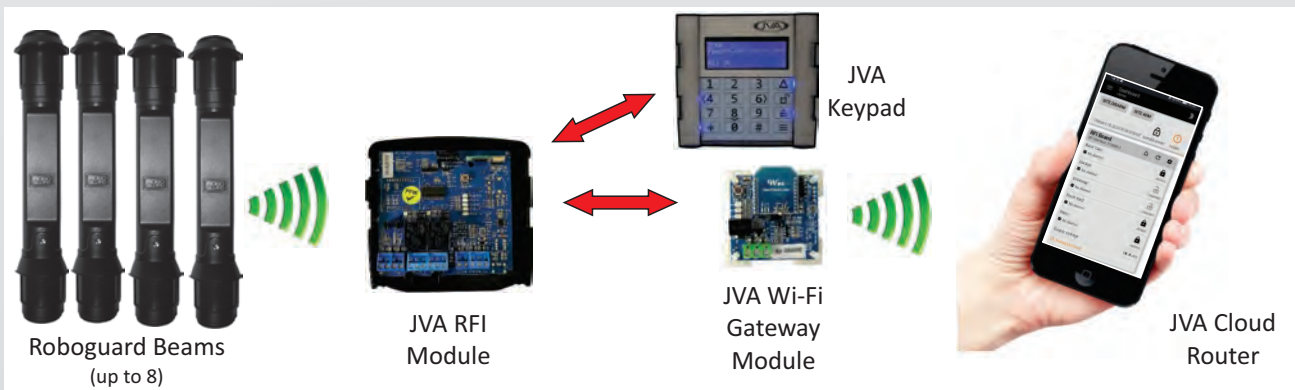

After Sales Service, Repairs and Consultancy

In security, product reliability and fast and efficient backup service is paramount. So, an installation is only as good as the security company's ability to provide sound products and service. Apart from its certification, JVA also offers a 2-year warranty on its products. JVA is also proud to be able to offer a 24-hour, turn-around on repairs to JVA products at their in-house repair and service facilities.

In addition, a countrywide JVA dealer network is ever present to provide fast and efficient in-field installation and backup service. Further, should an accredited JVA dealer not provide satisfactory backup service at an installation where he has installed and commissioned JVA products, the company undertakes to meet all obligations relating to those JVA products that have been installed. While fence maintenance, fault finding, and fence repairs are excluded from this undertaking, the company does offer consultancy services and advice on where and how best to solve fencing challenges. With over 50 years' experience in the field of electric security fencing, JVA's management is proud to be still servicing customers to whom we first sold in 1978.

Training

In addition to having trained sales personnel and in-house service technicians at all our distribution outlets, JVA also has fully equipped training facilities with trained facilitators where regular training courses, ranging from a basic introductory course on electric fencing to installation techniques, legal requirements and advanced technical training on our wide range of products is offered. We also run in-house customized training courses for specialized groups at locations such as venues serving security associations, farmer's security forums, schools, neighbourhood watch groups and game reserves.



JVA's close association with their vast range of international trading partners enables these companies to keep abreast with the latest international trends, developments, and requirements. JVA South Africa offers a comprehensive SAQA registered course and examination to qualify as an installer registered to issue a *Certificate of Compliance*. Ndlovu Fencing (Pty) Ltd, JVA's African distributors, is a leading role player in the setting up of the current South African Electric Fencing Standards and Regulations and Ndlovu's management are members of associations such as SASA, SABS Standards Committee, the Electric Fence and Components Manufacturer's Association, ESDA and the South African Game Fencing Association.



Do's and Don'ts

Do's

- Do select the right energizer for the job on hand. Determine the fence load and check that the energizer can cope with this load.
- Do make sure that your system is well earthed.
- Do place the energizer in a safe location and out of reach of children.
- Do secure all joints with either line clamps or ferrules.
- Do seal the joints to eliminate any corrosion.
- Do be conversant with the law and codes of practice applicable to electric fencing (SANS 10222-3).
- Do consult local bylaws that may impact your installation.
- Do make sure that your client is fully conversant with the workings of the unit you have installed.
- Do make a sketch of your layout and of the wiring configuration of the fence. Retaining this will facilitate fault finding and maintenance.
- Do make sure that your supplier can service the unit you have chosen and that spares are readily available.
- Do make sure that your installer is a registered installer and ask for references.
- Do make sure that you receive a Certificate of Compliance from the installer.
- Do make sure that the energizer you have installed is certified and meets the required statutory safety requirements (SANS 60335-2-76:2006).
- Do consult your neighbour before installing an electric security fence. Assuming you meet all the legal requirements, s/he has no reason to object.
- Do let only suitably qualified people operate your system and limit the number of key holders.
- Do make sure that the energizers are synchronized where there is the possibility of a person touching two fence lines powered by two different energizers.
- Do display warning signs as per the legislation.



Don'ts

- Don't electrify barbed wire.
- Don't include H.T. feed-out wires and H.T. return wires in the same conduit.
- Don't include H.T. wires in the same conduit as low voltage communication cables, as you will encounter induction problems.
- Don't combine unlike metals, i.e. copper earth stakes attached to galvanized wire, as electrolysis will occur and your wires will soon corrode away.
- Don't have an overhang that encroaches on your neighbour's property or over municipal property.
- Don't install two energizers on the same fence line.
- Don't earth your energizer to a mains or telecommunication earth system.
- Don't attach your earth to taps, dairy, or shower pipes as you could experience induced shocks.

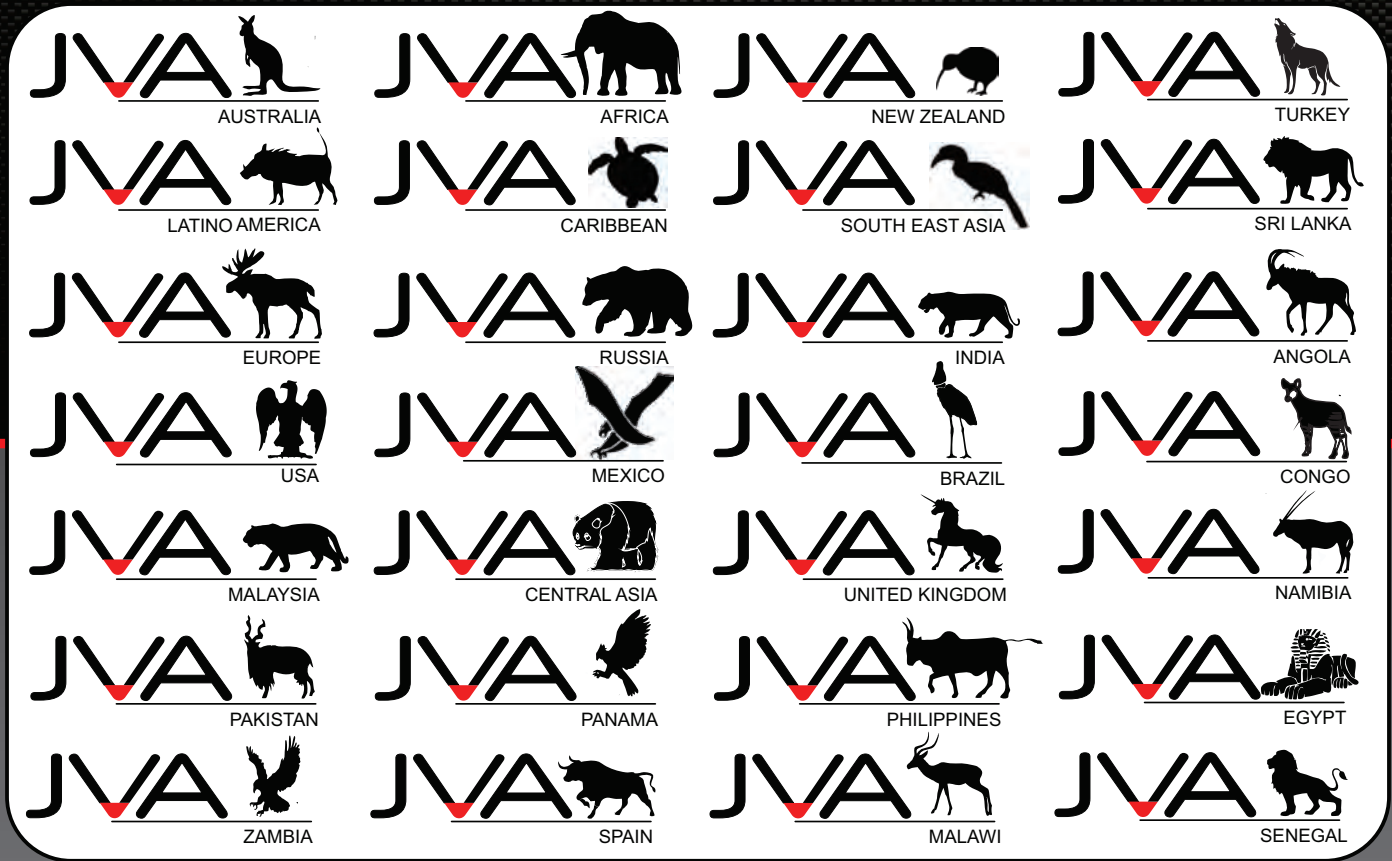

*JVA electronic products are proudly designed
and manufactured in Australia*



Australian Head Office

JVA Technologies Pty Ltd

ABN: 93 123 853 654

Add: 55 Kabi Cct, Deception Bay
Queensland, 4508

Tel: +61(0)7 3103 0582

Website: www.jva-fence.com.au

Email: sales@jva-fence.com.au

Skype: [jva.technologies](https://www.skype.com/jva.technologies)



African Head Office

Ndlovu Fencing Pty Ltd

Add: 219 Jet Park Road
Jet Park, Johannesburg

Tel: +27 011 397 3507

Website: www.jvasecurity.com

e-mail: swilliamson@jva-fence.com.au

Skype: [slj.williamson](https://www.skype.com/slj.williamson)



USA Head Office

JVA Monitored Fencing

Add: 4838 FM2001
Lockhart, Texas

Tel: +1 512 413 8661

Website: www.jva-usa.com

e-mail: billy@jva-us.com

Although the information presented in this product catalogue is believed to be accurate and reliable, no responsibility for inaccuracies can be assumed by JVA Technologies. Performance data is typical only and variations owing to component manufacturing tolerances are normal.